

AO Reichert SERIES ONE-FIFTY STANDARD LABORATORY MICROSCOPES

REFERENCE MANUAL

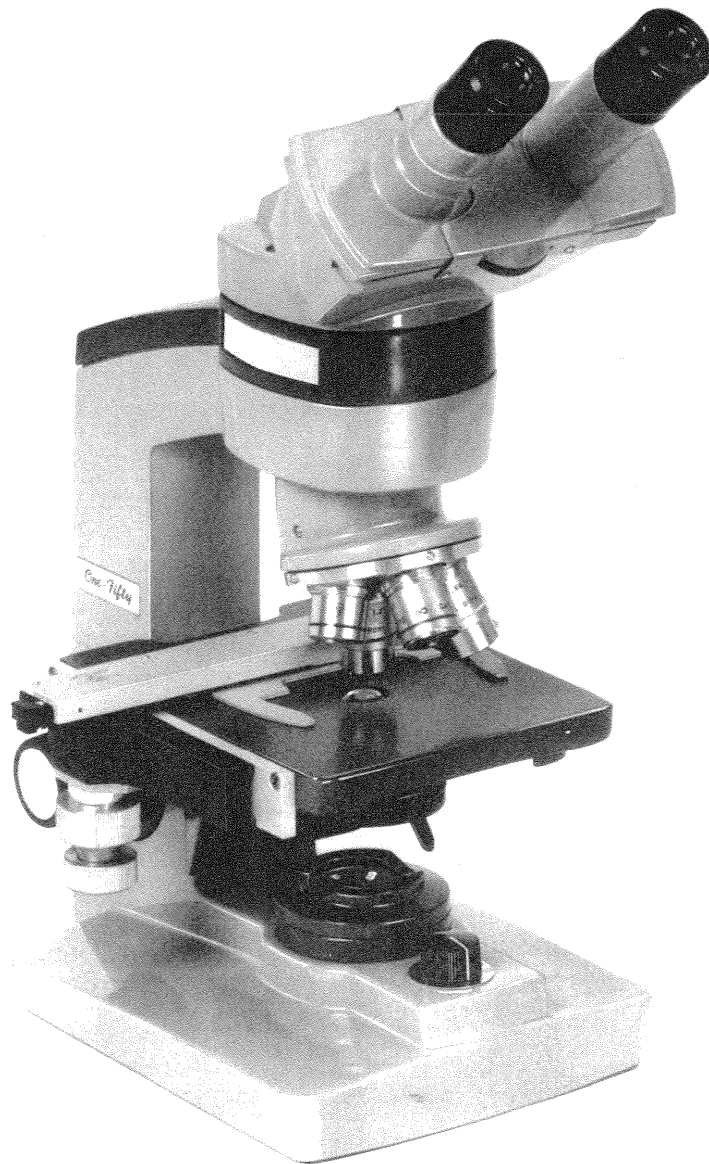

Price \$1.00

© AO Reichert Scientific Instruments 1984

AO Reichert[™]
AO Reichert Scientific Instruments
Division of Warner-Lambert Technologies, Inc.
P.O. Box 123, BUFFALO, NEW YORK 14240 U.S.A.
(716) 891-3000

WARRANTY

For 1 year from the date of purchase by the end-user, AO Reichert Scientific Instruments will repair or replace, at its option, this product for shipping charges only, if defective in workmanship or material. Contact your ordering dealer for instructions and furnish original invoice information.

This warranty does not apply if the product has been misused in any way, or has been altered or repaired by other than an authorized AO Reichert Representative.

THIS WARRANTY IS IN LIEU OF ALL OTHER WARRANTIES IMPLIED OR EXPRESSED. ALL IMPLIED WARRANTIES OF MERCHANTABILITY OR FITNESS FOR A PARTICULAR PURPOSE ARE HEREBY DISCLAIMED.

No one is authorized to make any obligations for AO Reichert not in accordance with the above. AO Reichert shall under no circumstances be liable for special, incidental or consequential damages from any negligence, breach of warranty, strict liability or any other theory arising out of or relating to the design, manufacture, use or handling of the product.

CLAIMS AND RETURNS

If discrepancies are discovered, an immediate report should be made to the customer's ordering point referring to the packing list number. All packing should be carefully examined to insure that no small items are overlooked. Claims for loss or damage in transit should be made directly to the transportation company.

If, upon delivery, the outside of the packing case shows evidence of rough handling or damage, the transportation company's agent should be requested to make a "Received in Bad Order" notation on the delivery receipt. If there is no exterior evidence of rough handling upon delivery, but concealed damage is evident upon unpacking the shipment within 48 hours of delivery, the transportation company should be requested to make out a "Bad Order" report. This procedure is necessary in order to maintain the right of recovery from the carrier.

Customers are requested to contact their ordering dealer for permission to return any goods for any reason. The request should indicate the date and number of the invoice, or packing list. If arrangements are made for a return, the material should be plainly tagged with the customer's name and address, carefully packed and shipped PREPAID.

PRODUCT CHANGES

AO Reichert reserves the right to change designs or to make additions to or improvements in its products without imposing any obligation on itself to add such to products previously manufactured.

The equipment supplied may not agree in all details with our description or illustrations because instruments are subject to modification and improvement.

SERVICE

Repairs should be performed only by qualified service personnel. Complete repair facilities are available at many AO Reichert authorized dealers, and AO Reichert Technical Service Centers in Buffalo, NY, Rosemont, IL, Chatsworth, CA, Edison, NJ, and Dallas, TX.

AO Reichert Scientific Instruments
DIVISION OF WARNER-LAMBERT TECHNOLOGIES, INC. P.O. Box 123, Buffalo, N.Y. 14240

TABLE OF CONTENTS

Introduction	4	Simple Measurements	10
Preliminary Procedure	5	Common Microscope Terms	11
Operating Procedure	6	Table of Resultant Magnifications, Field of View and Working Distances	16
Correct Diaphragm Settings	7	Proper Care of Series One-Fifty Microscope	16
Use of 100X Oil Immersion Objective	8	In-Base Illuminators	18
Auxiliary Swing-In Condenser	9	Mirror Assembly	18
Attaching No. 1534 Mechanical Stage Controls .	9		
How to Reset AO Reichert Autofocus Stop.....	9		

Optical and Mechanical Features of THE MICROSCOPE

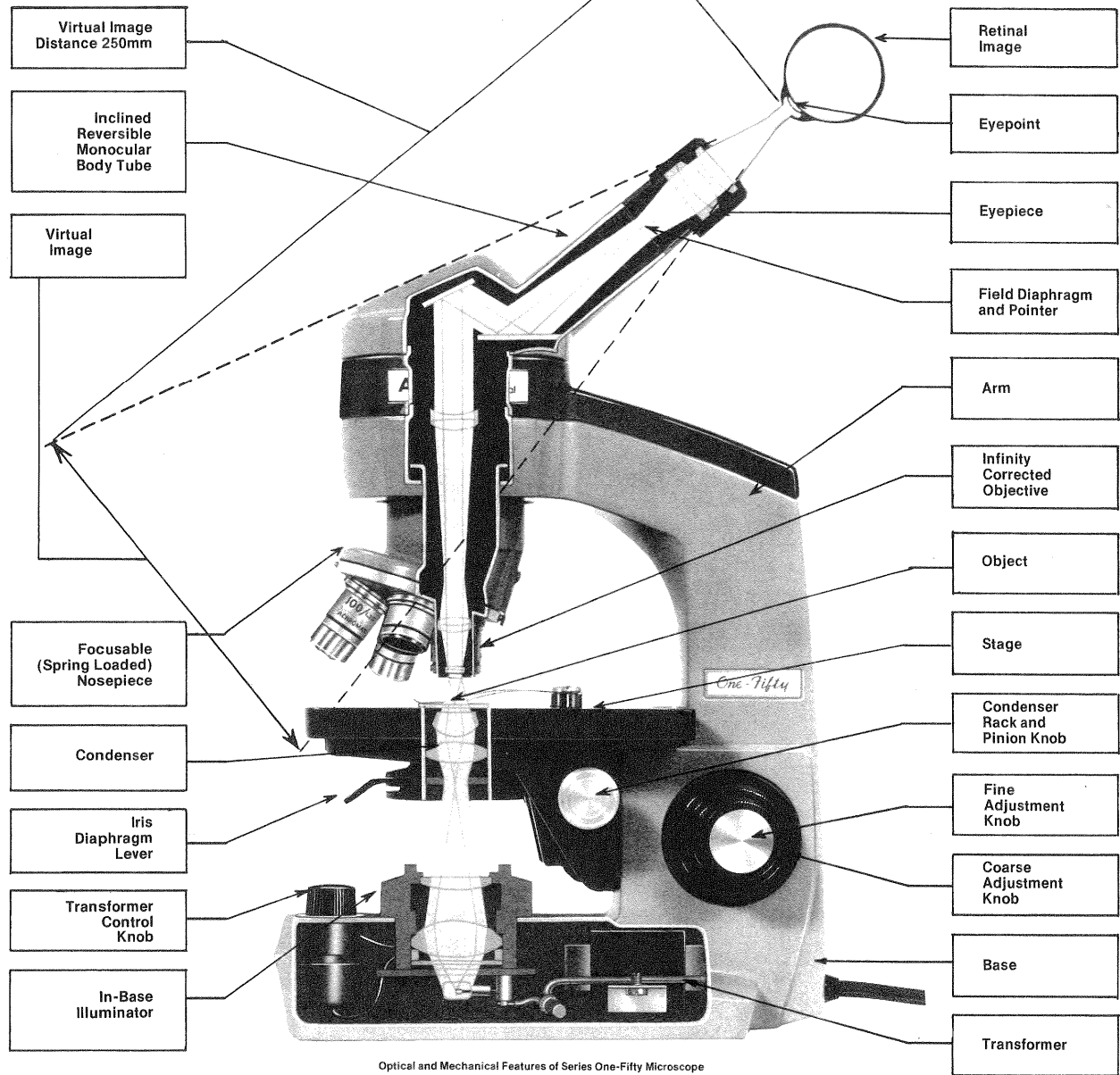

Optical and Mechanical Features of Series One-Fifty Microscope

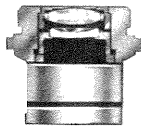

Cross section of scanning objective, 4X.

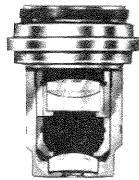

Cross section of low power objective, 10X.

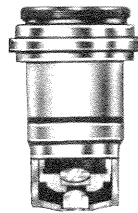

Cross section of "high dry" objective, 45X.

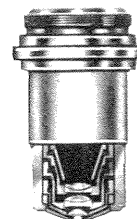

Cross section of oil immersion objective, 100X.

AO Reichert™

AO Reichert Scientific Instruments
Division of Warner-Lambert Technologies, Inc.
P.O. Box 123, BUFFALO, NEW YORK 14240 U.S.A.
(716) 891-3000

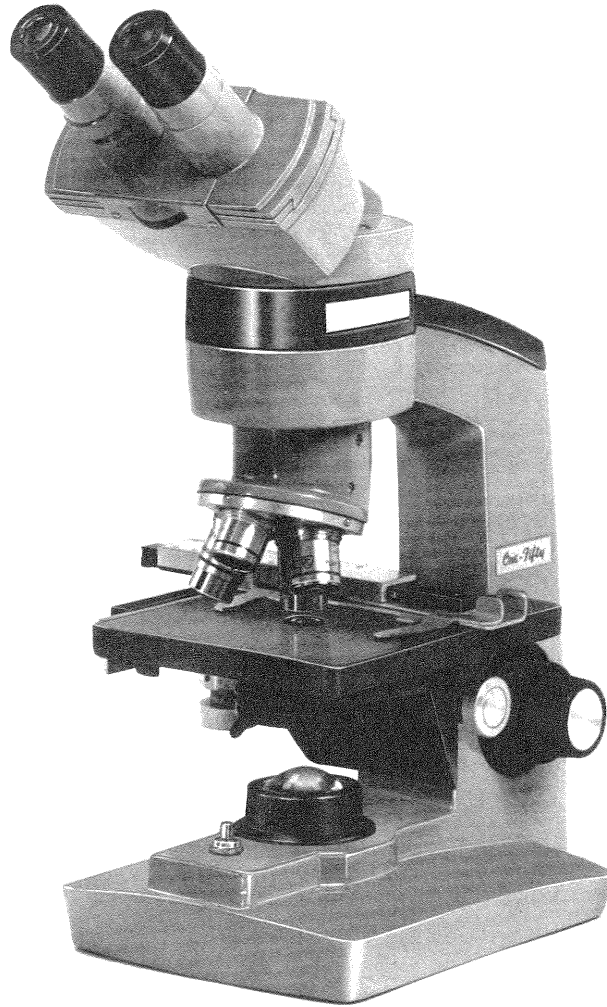

AO REICHERT SERIES ONE-FIFTY MICROSCOPE

INTRODUCTION

You now possess one of the finest and most precise scientific instruments available on the market today.

You will enjoy the simplified operation of a superior standard laboratory microscope featuring an exclusive, infinity corrected system. With the advanced optics of your Series One-Fifty microscope, you'll find your field of view larger . . . enjoy sharp, crisp focus . . . enhance your technique and accomplishment. With proper care, your AO Reichert Series One-Fifty microscope assures you years of satisfying, trouble-free service.

PRELIMINARY PROCEDURE

1. Remove the microscope from its shipping carton by grasping the arm of the instrument; support beneath the base with the other hand. Whenever the position of the microscope is changed, always carry in the illustrated manner.
2. Place the microscope on a firm table or bench. Select a chair, or adjust stool height, so that the user will be comfortable in near-erect posture when viewing through the inclined eyepiece.
3. Your Series One-Fifty model is equipped with an *In-Base illuminator* and many users prefer to reverse the body of the microscope for easier access to slides, objectives, or iris diaphragm lever.

To position the instrument with the arm away from the user, remove screws (a) with correct sized screwdriver; reverse inclined body 180° as illustrated and re-assemble.

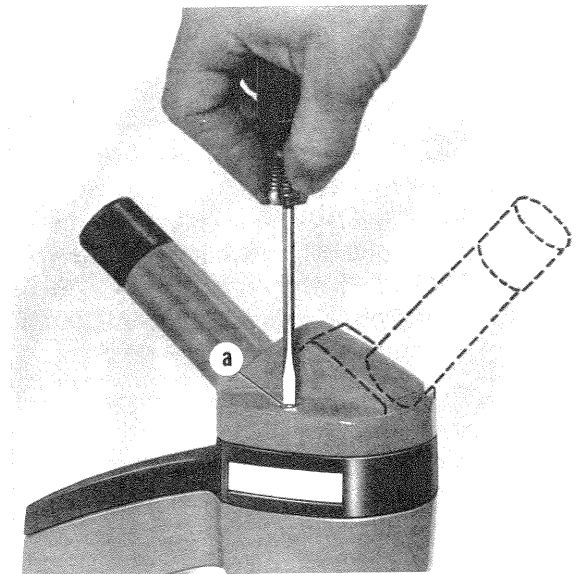

OPERATING PROCEDURE

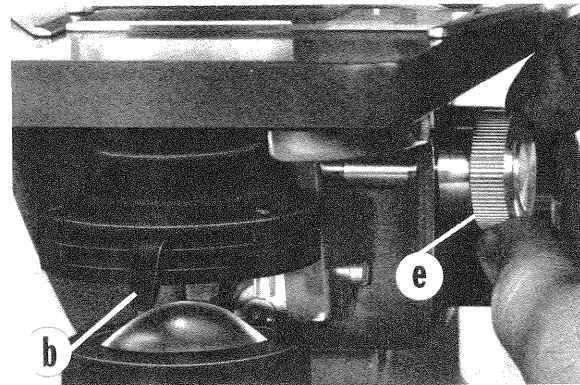
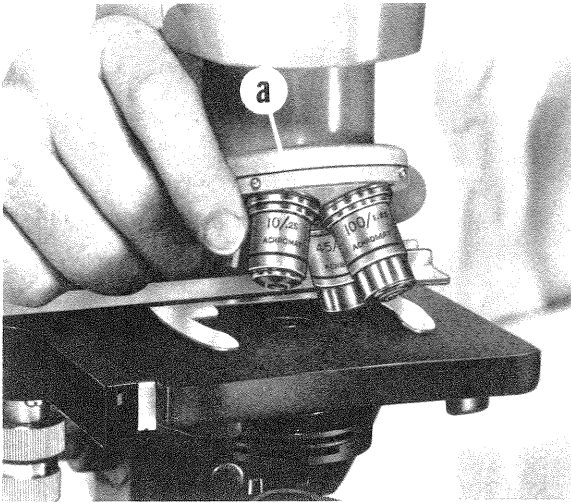

The following step-by-step operating procedure should be carefully observed when first using an AO Reichert One-Fifty Microscope. Because the instrument is designed specifically for fast, simplified use, correct operating technique soon becomes automatic.

1. Raise the nosepiece using a coarse adjustment knob (c). This provides greater access to the stage when slide is positioned.
2. Rotate the nosepiece (a) so that the "green" coded, 10X objective is in operating position.
3. Open iris diaphragm (b) approximately half way.
4. Turn on In-Base illuminator. If your instrument is equipped with a built-in continuously variable transformer ("L" Models) turn control to 5V setting. Otherwise simply "turn on" illuminator by depressing push-type switch.
5. Place a good stained specimen slide of standard thickness (approx. 1.25mm) on the stage and with the naked eye position the specimen directly above the center of the condenser.
6. Raise the microscope condenser by means of the condenser rack and pinion knob (e) until the top of the condenser is approximately the thickness of a piece of paper beneath the slide.

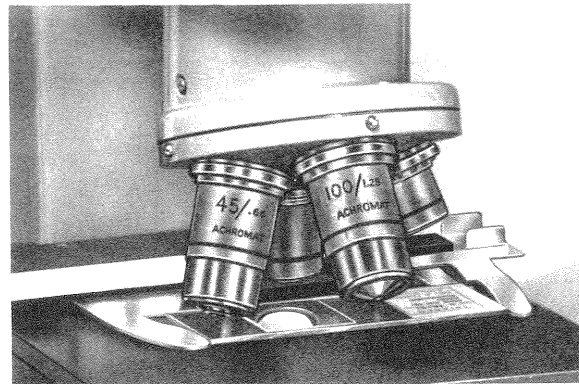

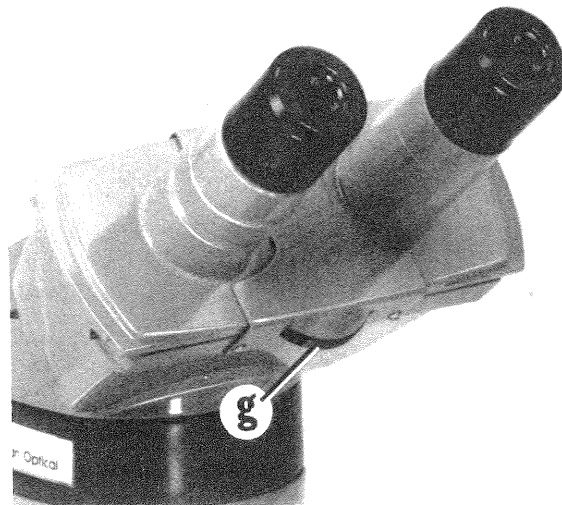
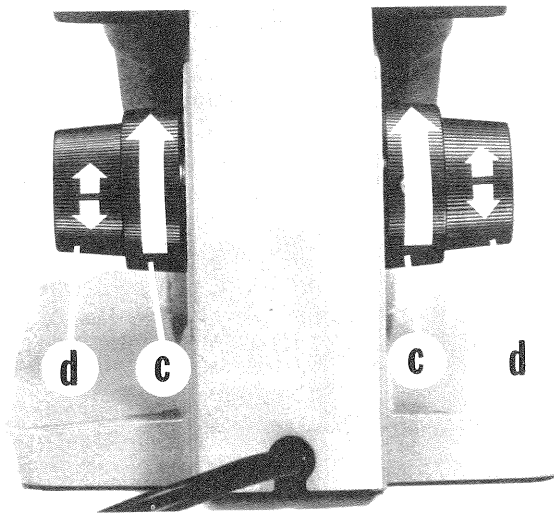

7. Rotate the coarse adjustment knob (c) to lower the nosepiece until the positive stop is reached. View through the eyepiece(s) and, without disturbing the coarse adjustment setting, slowly rotate a fine adjustment knob (d) in the appropriate direction until specimen detail is in sharpest possible focus. (If using a separate illuminator, adjust mirror tilt as required.)

Note: If using a *monocular* body, to avoid eyestrain keep both eyes open while viewing through the instrument.

If your Series One-Fifty Microscope has a binocular body, use the thumb wheel (g) to adjust the interpupillary distance. The left eyepiece tube is focusable to compensate for refraction differences of the eyes.

The correct procedure is to bring the specimen into sharpest possible focus with a fine adjustment knob using the right eyepiece only, while covering the left eyepiece. To focus for the left eye, first turn the knurled ring on the left eyetube fully counterclockwise. While viewing the specimen with the left eye only turn the knurled collar clockwise until the specimen is in sharp focus. *Do not* adjust fine adjustment knob during this procedure.

8. Remove an eyepiece to view the back aperture of the objective. Close the condenser iris diaphragm . . . then re-open until the leaves "just" disappear from view to obtain the full resolving power of the microscope. The condenser iris diaphragm may be closed slightly to enhance contrast.
9. Once specimen detail is in sharp focus using the 10X objective, it is then possible to rotate the nosepiece to other objectives without changing the position of the coarse adjustment knob. Very little refocusing with the fine adjustment is required since AO Reichert Series One-Fifty microscope objectives are parfocal.

You should remember, however, that the iris diaphragm setting must be changed, whenever a different objective is used. As magnification increases, the condenser iris diaphragm is opened as required.

CORRECT DIAPHRAGM SETTINGS

With experience, correct setting of the iris diaphragm can be made from the appearance of the specimen image. Many users fully open the iris diaphragm and then close down until desired specimen contrast is achieved without loss of detail or resolution.

OPERATING PROCEDURE FOR USE OF 100X OIL IMMERSION OBJECTIVE

Since numerical apertures of objectives vary directly with the initial magnifications of objectives, it is necessary to change the substage diaphragm setting whenever the nosepiece is rotated to another objective. The greater the initial magnification of the objective . . . the larger its numerical aperture . . . consequently, the wider the cone of light you'll have to present to the specimen and objective by properly opening the substage diaphragm.

To theoretically derive the full resolving power of a given objective, the back lens of the objective must be completely and evenly illuminated. This can be checked by removing the eyepiece and peering into the eyetube to see whether the above conditions are satisfied; if not, the iris diaphragm opening must be changed to meet the required conditions.

In general practice, however, the substage aperture diaphragm is very rarely set to fill the full numerical aperture of the objective, but rather is acceptably adjusted so that approximately $\frac{3}{4}$ of the back lens of the objective is filled with light. Experience and actual experiment will be your best guide and you will soon find it unnecessary to remove the eyepiece for such settings . . . you'll automatically set the iris diaphragm apertures, as demanded by specific specimens, according to the best possible contrast attainable.

Unstained and living specimens, because of their low contrast characteristics, can usually be viewed more effectively by setting the diaphragm at or near minimum opening. Reducing the diaphragm setting increases definition, contrast and depth of focus at the sacrifice of resolution and introduces diffraction. Do not, however, close it to such an extent as to introduce undesirable diffraction or distortion of specimen detail . . . select the best compromise by trial and error.

Use of the 100X oil immersion objective is best accomplished . . . without danger of damaging specimen slide and objective . . . by utilizing the full value of the protective **Autofocus** stop feature. Proceed in the following manner:

1. Focus onto the specimen progressively with the 10X and 45X objective following steps in "Operating Procedure".
2. Fully raise the nosepiece by means of a *coarse* adjustment knob without disturbing the position of the fine adjustment knob.
3. Place a small drop of non-drying Crown or Cargille's immersion oil (mineral oil or other substitutes should not be used) in the center of the circle of light formed on the specimen slide.

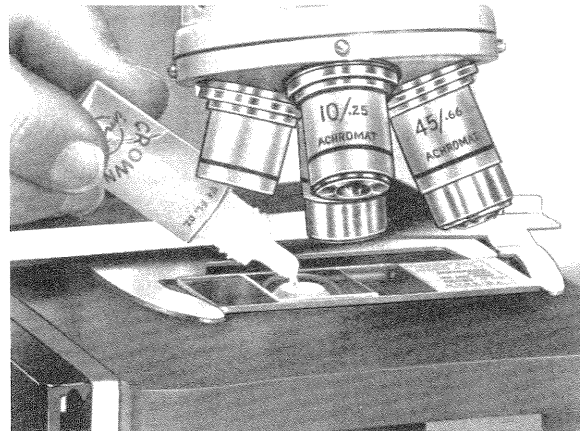

4. Turn the nosepiece to the "red" coded, 100X objective.
5. Grasp a coarse adjustment knob and rotate it to its original stop position.
6. Bring the specimen into sharp focus with fine adjustment knob.

Note: In following the above procedure, remember the advisability and necessity of opening the condenser iris diaphragm.

SCREWS FOR MICROSCOPE BODIES ARE NOT INTERCHANGEABLE

In the event that you wish to use a binocular body on your Series One-Fifty microscope in place of the monocular body — or monocular in place of binocular — please remember that the mounting screws are not interchangeable. Slightly longer screws are required for the binocular body. Use as follows:

**#76 Monocular Body — X32570-22 Screws
(2 required)**

**#77 Binocular Body — X32571-22 Screws
(2 required)**

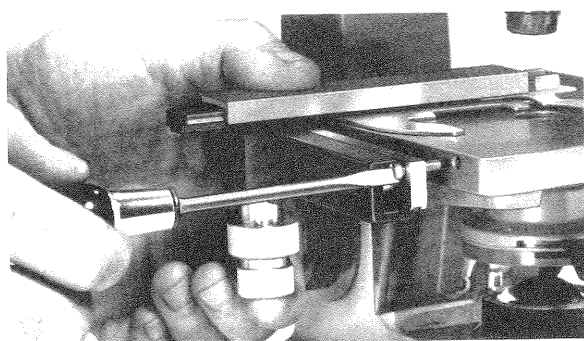

ATTACHING NO. 1534 MECHANICAL STAGE CONTROLS TO NO. 1586 SIMPLE STAGE

To convert the #1586 Stage to a mechanical stage, the #1534 is attached, as pictured, with two screws. The #1534 Mechanical Stage Attachment is held to very close tolerances in manufacture to insure proper fit to the stage. North - south, east - west motion should be smooth and easy, entirely free of any feeling of binding or friction drag against top of stage plate. The #1586 Simple Stage is pre-drilled to accept the #1534 Mechanical Stage controls.

HOW TO RESET AO REICHERT AUTOFOCUS STOP

Autofocus, originally developed by AO Reichert, is a quick focus-finder built into the coarse adjustment assembly. An outstanding convenience feature, Autofocus eliminates lost time in "searching" for correct focus with the coarse adjustment. Together with the spring loaded nosepiece, it eliminates slide breakage and objective damage.

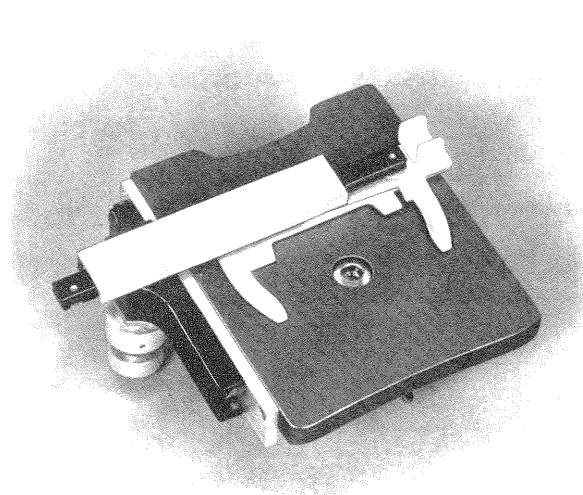

CATALOG NO. 1587A MECHANICAL STAGE CONSISTS OF NO. 1586 SIMPLE STAGE AND NO. 1534 MECHANICAL STAGE ATTACHMENT.

Autofocus stop is variable to accommodate thick chambers such as hemacytometers but does not require adjustment for slides which vary in thickness as much as $\pm 0.5\text{mm}$ from normal 1.25mm slide thickness. To vary or reset the **Autofocus** for thicker slides or chambers, or to reset at original position, follow these steps:

1. Use 10X objective.
2. Loosen Allen screw (a) of coarse adjustment knob (b) with "L" shaped 3/32" Allen wrench . . . do not under any circumstances disturb other Allen screws. An instructor should be present to make certain that latter rule is not violated.
3. Set fine adjustment (c) at mid-excursion by positioning the fine adjustment at three revolutions from the bottom stop of its range.

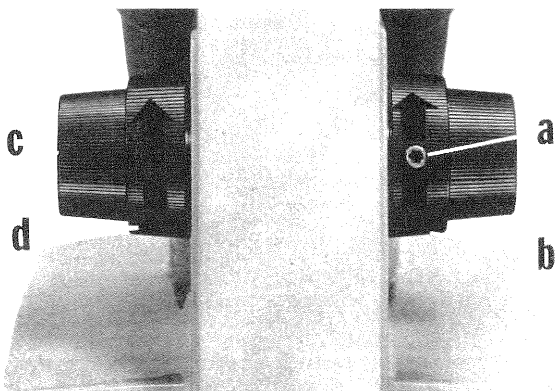

4. Place the specimen slide on the stage . . . orient directly above center of condenser.
5. Bring specimen detail in sharp focus by carefully rotating coarse adjustment knob (d) without changing setting of fine adjustment knob (c) established in step 3.
6. Now, rotate coarse adjustment knob (b) in the direction illustrated until you reach a positive stop . . . hold the knob in this position . . . and tighten Allen screw (a) securely.

SIMPLE MEASUREMENTS WITH SERIES ONE-FIFTY

10X Wide Field eyepiece includes a pointer which also may be used to conveniently determine approximate lateral dimensions of a specimen or specimen detail at the object plane. When the eyepiece is used with a 4X, 10X, 45X, or 100X objective, the base portion of the pointer represents approximately 160,

65, 15, and 7 microns respectively. (1 micron = .001 millimeter = $\frac{1}{25,400}$ inch)

EXAMPLE: *Specimen viewed under 10X eyepiece and 10X objective has a length of approximately 65 microns.*

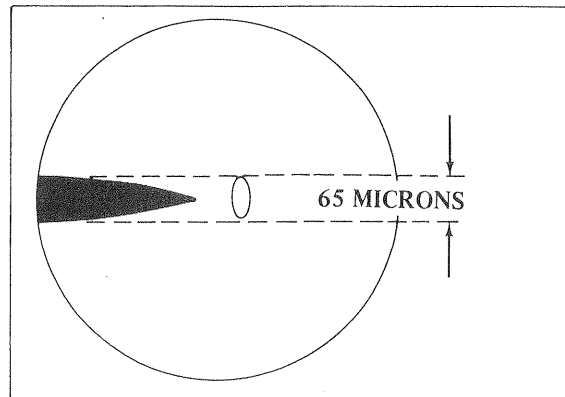

10X WIDE FIELD EYEPIECE WITH 10X OBJECTIVE

10X Huygenian eyepiece also contains a pointer which may be used to determine approximate lateral dimensions of a specimen at the object plane. When the eyepiece is used with a 4X, 10X, 45X, or 100X objective, the base portion of the pointer represents approximately 250, 100, 25, and 10 microns respectively.

EXAMPLE: *Spherical specimen viewed under 10X eyepiece and 10X objective has diameter of approximately 100 microns.*

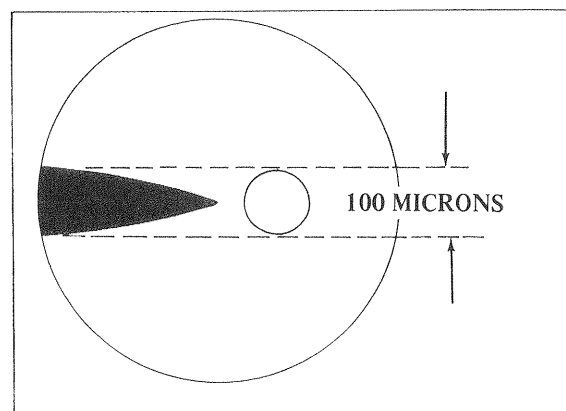

10X HUYGENIAN EYEPIECE WITH 10X OBJECTIVE

IMPORTANT: When using a binocular Series One-Fifty microscope, it is recommended that the eyepiece with pointer be used in the right, fixed tube of the microscope body.

COMMON OPTICAL AND MECHANICAL MICROSCOPE TERMS

Aberration, Chromatic Present in a lens system when the rays of the component colors of white light are not simultaneously brought to one focus, thus producing undesired color fringes in an image.

Aberration, Spherical When light rays of one color passing through the outer periphery of a lens do not come to the same focus as the rays passing through near the center. The image is more or less blurred.

Achromatic Literally free of color aberration. Lenses and prisms within the microscope are corrected to transmit a faithful image of the specimen virtually free of color fringes.

Alignment Mutual coincidence of optical and mechanical components along a common axis.

Aperture Diaphragm A rotatable disc diaphragm or iris diaphragm* located beneath the microscope condenser*. It is used to skillfully control the angle of the solid cone of illumination presented to a specimen and entering the objective. Resolution*, or contrast, and definition* of the specimen significantly depend upon the proper setting of the aperture diaphragm. It is important to note that the control of the intensity of illumination is not a function of the aperture diaphragm; absorption filters are used for this purpose.

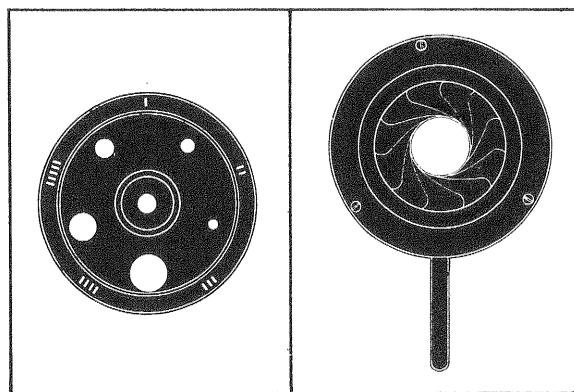

DISC DIAPHRAGM

IRIS DIAPHRAGM

Autofocus Stop Autofocus, originally developed by AO Reichert, is a quick focus-finder which essentially eliminates objective*, slide, and specimen damage; is also a definite time saver. Autofocus is built into the coarse adjustment assembly; can be easily reset when desired.

Bright-Field Illumination The most common type of illumination applied in ordinary microscopy. Specimen image appears dark against a brighter background. Bright-Field is the opposite of Dark-Field* illumination.

Coarse Adjustment The larger set of knobs which actuate the nosepiece assembly of AO Reichert microscopes. Used for rapid, or coarse, focusing onto specimen mounted on very thick or well-type slides. When standard thickness slides are used, the coarse adjustment is merely rotated to a distinct stop to take full advantage of "Autofocus".

Compound Microscope An exacting optical instrument used to magnify and resolve fine detail within a transparent specimen. It differs from the simple microscope (ordinary magnifier) in that it has two separate lens systems; an objective, located near the specimen, which magnifies the specimen in a definite amount; and an eyepiece* which further magnifies the image formed by the objective. The resultant magnification* observed by the eye is equal to the product of the primary magnification of both lens systems.

Condenser The lens or lens system to collect illumination light rays and converge them to a focus. Located directly beneath the microscope stage. Coupled with the aperture diaphragm, the condenser constitutes one of the most important and necessary features of a good microscope. For this reason, AO Reichert microscopes are equipped with condensers and diaphragms to controllably increase resolution, enhance contrast, reduce glare* and assure optimum results with all objective-eyepiece combinations.

*Term defined in alphabetical order.

Cover Glasses Square, rectangular or circular coverslips of thin, optically flat glass used to cover microscope slide specimens. The thickness of the cover glass affects the light rays and most microscope manufacturers design objectives for use with cover glasses having a thickness of 0.18mm. It is particularly recommended that cover glasses with thickness of $0.18 \pm .02$ mm be applied to all specimen slides which will be observed critically through a 43X or 45X objective.

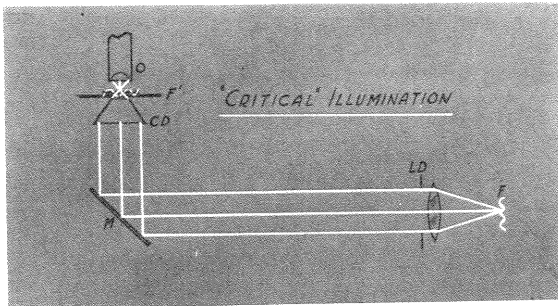

THE EFFECT OF A COVER GLASS

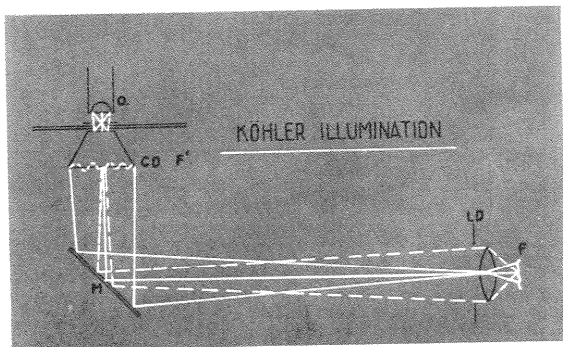

THE EFFECT OF COVER GLASS THICKNESS

Dark-Field Illumination A method of illuminating the specimen without admitting light directly into the objective. Specimen image appears bright against a dark background. Achieved by the insertion of a dark-field stop into the condenser mount of the microscope or the substitution of a dark-field condenser in lieu of a standard condenser.

Definition The faithfulness with which the optical system magnifies and reproduces the specimen detail. The brilliance, clarity, distinctness and sharpness of the microscope image.

Depth of Focus The thickness of the specimen which may be seen in focus at one time.

The greater the magnification, the greater the numerical aperture* and the shorter the focal length . . . the thinner is the layer in focus at one time. The lesser the magnification, the lesser the numerical aperture and the longer the focal length . . . the thicker is the layer in focus at one time.

The longer focal length lenses of lesser magnification are usually more satisfactory for the study of the general arrangement of the specimen because of the greater depth of focus . . . the field of view* is larger and the image brighter.

Dry Objective Microscope objectives designed to be used dry; that is, without immersion oil. The 40X, 43X or 45X objective is quite frequently referred to as the "high dry" objective; the 10X, "low dry" objective.

Empty Magnification Large magnification which increases size without enhancing resolution of the specimen detail. Although eye sensitivity varies from one individual to another, the limit of effective magnification should be in the range of 500 to 1000 times the numerical aperture (N.A.) of the objective. For example, a 43X objective with a N.A. 0.55 has effective maximum magnification of $1000 \times 0.55 = 550X$; a 45X, N.A. 0.66 objective, 660X.

Equivalent Focal Length Generally used to designate the true focal length of a microscope objective.

Eyepiece The topmost optical lens system of a microscope, sometimes referred to as "ocular", which is used by the observer to further magnify the primary image transmitted and amplified by the objective. With the eye positioned at the eyepoint* of the eyepiece, it forms a virtual image* at approximately 250mm from the eye. The two most common types of eyepieces are called Huygenian* and Wide Field. The latter, as the name implies, provides approximately a 25% larger field of view and subtends a higher

eyepoint. Consequently, it is better suited for observing larger areas of a specimen and accommodating users wearing eyeglasses.

Eyepoint The point on the axis above the eyepiece where all the principal rays of light intersect (a). For best results, the eye should be positioned at or above this point which can be found by holding a ground glass or paper tissue at about 7.4mm above the eyelens (top lens) of the Huygenian eyepiece, or 16mm above the eyelens of the Wide Field eyepiece supplied with AO Reichert Series One-Sixty and One-Fifty microscopes.

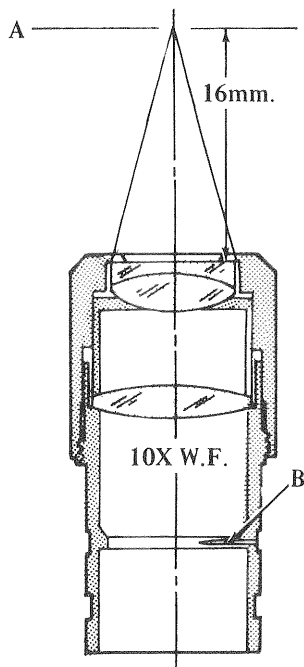

Field Diaphragm A diaphragm limiting the field of view. In an eyepiece supplied with Series One-Sixty or One-Fifty, the diaphragm is adjacent to the pointer (b).

Field of View The visible area seen through the microscope when a specimen is in focus. It is usually expressed in mm diameter and can be determined by focusing onto a finely graduated, transparent millimeter scale placed on the microscope stage. See Table at end of terms and note that the field of view varies directly with the resultant magnifications . . . the greater the magnification, the smaller the field of view.

Fine Adjustment Smaller set of focusing knobs controlling the precise, fine movement of the ball-bearing nosepiece as-

sembly. The mechanical slip-clutch at each end of fine adjustment excursion prevents jamming and damage to the focusing mechanism.

Glare Unfavorable light scattered by a specimen spoiling image detail. Scattered or strayed light within a microscope system is generally caused by improper use of diaphragms and condensers.

Huygenian Eyepiece Relatively simple, yet suitable, type of eyepiece invented by Christian Huygens, Dutch astronomer and mathematician.

Illumination The full capabilities of a microscope are not obtained unless the illuminator is efficient. Daylight is not very satisfactory because of its variability and, consequently, artificial light is generally used. The In-Base illuminators designed for use with the AO Reichert Series One-Sixty and One-Fifty microscopes are ideally suited for good results. They are an integral part of the instruments; assure correct alignment at all times; fully illuminate the field of view and satisfy the numerical aperture requirements of all objectives.

Immersion Oil An oil having proper refractive index*, dispersion and viscosity characteristics for use between a 100X "oil immersion" objective and specimen cover glass. Crown or Cargille's non-drying oils should be used instead of cedarwood or other oils for this purpose.

Iris Diaphragm An assembly of thin metal leaves controllable by a lever to produce variable sized opening. It is generally associated with microscope condensers and illuminators of intermediate and advanced types.

Lens A convex or concave transparent glass component for changing the direction of rays of light and thus magnify or reduce the apparent size of objects.

Light The human eye can see only with radiation of 400 to 700 millimicrons and is most sensitive at 555 millimicrons, or .555 microns, yellow-green light. (1 micron is equal to one-thousandths of a millimeter.) Light is radiant energy of

*Term defined in alphabetical order.

above wavelengths which upon reaching the retina of the eye stimulate nerve impulses to produce the sensation of vision. White light is composed of a mixture of colored light of different wavelengths. When specimens are too transparent to be seen effectively, they may be stained . . . then the specimen can be seen by the color image formed as the dye absorbs certain wavelengths of light and transmits the others to the eye.

Magnification The ratio of the apparent linear size of an object as seen through the microscope (the virtual image) to the size of the object as it appears to the unaided eye at a distance of ten inches. The ratio is usually expressed in terms of "diameters", "power", "X", or "times", for example, 100X.

The compound microscope has two separate lens systems. The one nearest the object (the objective) magnifies the specimen a definite initial amount. The other lens system, the eyepiece, further magnifies this image (real image*) so that the resultant image seen by the eye (virtual image) has a magnification approximately equal to the product of the two systems. The primary magnification of objectives and eyepieces are engraved on each such part.

To determine exact magnification of the combined systems, project the image of a stage micrometer onto a screen or ground glass located 250mm above the eyepoint and measure the magnification directly against an accurate millimeter scale.

Magnification alone is not the aim of the finest microscopes. See "Empty Magnification". The amplified or enlarged image is not helpful unless more detail . . . resolution . . . becomes visible.

Numerical Aperture (N.A.) A designation, usually engraved on objectives and condensers, expressing mathematically the solid cone of light delivered to the specimen by the condenser and gathered by the objective. The higher the numerical aperture of an objective the greater the resolving power of the objective. To satisfy this condition, however, it is necessary that the N.A. of the condenser

be equal to or greater than the N.A. of the objective. For example, a condenser with N.A. 0.55 is insufficient to derive the full resolving power of a 100X oil immersion objective rated at N.A. 1.25.

Objective The complex lens system located directly above the object or specimen. It is the most exacting sub-assembly of a microscope since it is called upon to faithfully magnify and resolve specimen detail.

The bottom-most lens of the objective produces the magnification and the balance of lenses redirect the image forming rays to the optical axis at the back focal plane of the objective where the resultant image is still further relayed and magnified by the eyepiece. All objectives supplied with the AO Reichert Series One-Sixty and One-Fifty microscopes are parfocal*, parcentered*, and infinity corrected for superior optical and mechanical performance, and color coded for easy identification. See Table at end of terms re: working distance, resultant magnification and field of view.

Optics The science dealing with the properties of light and vision.

Optical Glass A very high quality glass made especially for use in scientific instruments. Good microscope lenses and prisms are made from such glass having specific refractive index* and dispersion values.

Optical Filters Colored or neutral, all glass or laminated gelatin filters used to modify the light source. The light from a tungsten filament bulb is yellow and is usually rendered whiter by inserting a blue filter to absorb the excess red. The selective use of complimentary filters can do much to enhance stained detail within specimens.

Parcentered A term applied to objectives indicating that when a specimen detail is in the center of the field of view of one objective, the detail will essentially remain in the center of the field when the next objective is rotated into position.

Parfocal A term applied to objectives and eyepieces when practically no change in focus has to be made when one power is

substituted for another. The objectives on the revolving nosepiece of a microscope are parfocalized so that only a slight turn of the fine adjustment is required when changing from low to a higher power objective.

Real Image (Aerial Image) The image formed in space by a system of lenses. Its presence can be viewed only by the insertion of a receiving screen, ground glass plate or projection screen.

Refraction The bending of a ray of light with a change in speed when it enters a transparent medium of different density.

Refractive Index A relationship between the sine of the angle of incidence and the sine of the angle of refraction when a ray of light passes from air to a transparent medium.

Resolving Power (Resolution) The ability of a microscope to reveal fine detail. It is stated as the least distance between two lines or points at which they are seen as two, rather than as a single blurred object.

Resolving power is a function of the wavelength of light used and the greatest cone of light which can enter the objective. The numerical aperture is engraved on objectives and may be used to compute the limit of resolution by applying formula $R = \frac{\text{wavelength}}{2 \text{ N.A.}}$. For example, a 10X objective, used at full numerical aperture N.A. 0.25, with green light having a wavelength of 0.56 micron:

$$R = \frac{.56}{2 (0.25)} = 1.1 \text{ micron.}$$

Retinal Image The image formed at the retina of the eye.

Spectacles and Eyeglasses Spectacles and eyeglasses corrected only for near or farsightedness need not be worn when using a microscope. The person merely focuses the instrument with the fine adjustment differently from someone else. If, however, spectacles have a correction for astigmatism, it is desirable that they be worn because the microscope obviously cannot correct for such deficiency

and severe eyestrain and poor vision may result.

Virtual Image The apparent size and position of the object specimen. This image (not a real image) seen with the microscope appears to be about as far away as a book is held when reading print of average size. This distance is generally agreed to be about 10 inches.

Working Distance The distance between the front mount of the objective and the top of the cover glass when the microscope is focused on a thin specimen preparation. The greater the primary or initial magnification of the objective, the smaller the working distance. (See Table on next page.)

Since all objectives are designed for use with cover glass thickness of 0.18mm, make it a practice to use this proper thickness cover glass over all preparations. It is significantly important to recognize that too thick a preparation may make it impossible to focus onto its deepest detail with the 100X, or possibly with a 43X or 45X objective, because of the relatively short working distance of high powered objectives.

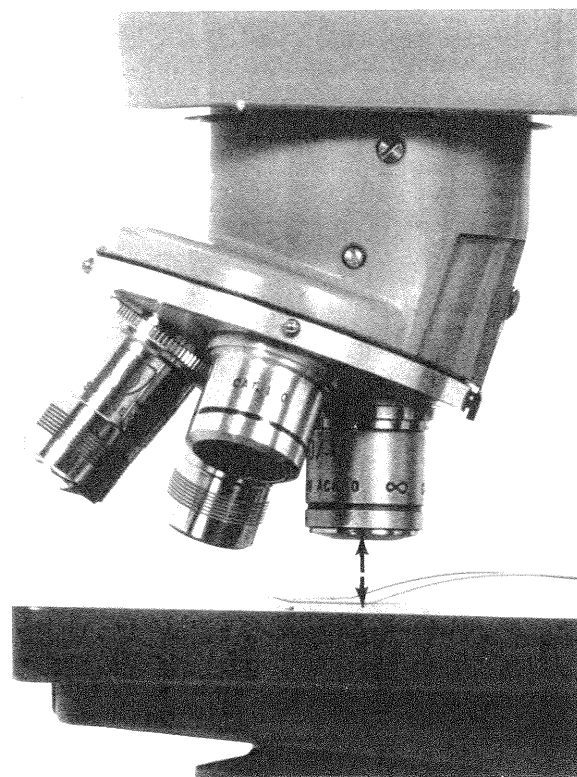

*Term defined in alphabetical order.

TABLE OF RESULTANT MAGNIFICATIONS, FIELD OF VIEW AND WORKING DISTANCES						
OBJECTIVES					EYEPIECE	
					#138 Wide Field 10X	
Catalog Number	Initial Magnification	Numerical Aperture	Equivalent Focal Length	Working Distance	Resultant Magnification	Field of View
130	4X	.10	40mm	17.5mm	40X	4.2mm
1026	10	.25	18	9.1	100	1.9
1116	45	.66	4	.7	450	.41
1079	100	1.25	1.8	.10	1000	.18

PROPER CARE OF SERIES ONE-FIFTY MICROSCOPE

The Series One-Fifty Microscope is a precision instrument made from valuable materials by expert craftsmen and should be treated accordingly. If properly used and cared for, it will literally last a lifetime without appreciable wear or change in appearance and performance.

The following rules, cautions and maintenance hints should be observed:

1. Microscope Stand and Mechanical Parts

- a. Use both hands when carrying the instrument. One, firmly grasping the arm of the microscope; the other, beneath the base. Avoid sudden jars.
- b. The dove-gray finish is tough and durable . . . resists chipping, staining and

corrosive action of common laboratory chemicals. Clean with very mild soap or detergent solution when required. Other metal surfaces may be similarly cleaned. Dampen, do not soak, your lint-free cloth for this purpose. Finally, wipe off thoroughly and buff with dry lint-free cloth.

- c. The bothersome chore of cleaning and relubricating moving parts is effectively minimized in the Series One-Fifty Microscope. All moving parts are protected within the microscope stand and lubricated with a long lasting special purpose lubricant. Disassembly of parts and replacement of these lubricants is rarely if ever necessary under normal laboratory working conditions.

- d. Store your microscope in a clean, dry place and keep it covered with the supplied plastic cover when the instrument is not in use.

2. Optical Parts

Cleanliness of all optical components of the microscope is important for good optical performance. If any optical surface becomes badly coated with dust or dirt, all such loose dust or dirt should be blown off with a syringe or dusted with a camel's hair brush before attempting to wipe the surface clean.

Optical surfaces should be cleaned with a lint-free, soft, linen cloth, lens paper or a Q tip just moistened with distilled water. Always promptly wipe the surface dry, using a circular motion, before allowing it to air dry.

Glass surfaces should never be touched with the fingers because they will leave a greasy smear and, frequently, corrosive perspiration. Do not clean optical parts unnecessarily. If the specimen image appears to have deteriorated and lacks definition —

- a. Blurred specks appearing in the field of view are generally caused by dust, lint or smears contaminating the eyepiece or specimen cover glass. If the specks move upon rotation of the eyepiece, clean the topmost lens of the eyepiece. If the specks move upon the slight displacement of the specimen slide, clean the cover glass.
- b. Check the quality of the specimen preparation by using a better area of the slide or insert a slide of known results; or turn the nosepiece turret to another objective.

If image quality is improved by turning nosepiece, cleaning of the bottom-most lens of the objective is indicated.

No part of the microscope is quite so vulnerable to lack of complete cleanness as the front lens of the objective. Whenever lack of contrast, cloudiness, or poor definition is encountered, carefully check the condition of the front lens with a magnifier. The 10X

wide field eyepiece, reversed, is an excellent magnifier for this purpose.

The 4X and 10X objectives with fairly large front lenses can be cleaned with a cloth or lens tissue wrapped around the finger and moistened with distilled water. The 45X and 100X oil immersion objectives require a little more care. The surface of these front lenses can be readily cleaned with a Q tip or with a toothpick covered with cotton at the tip. Moisten the cotton with water and squeeze almost dry. Wipe the front lens lightly without applying any undue force or scrubbing action. Check with magnifier after cleaning.

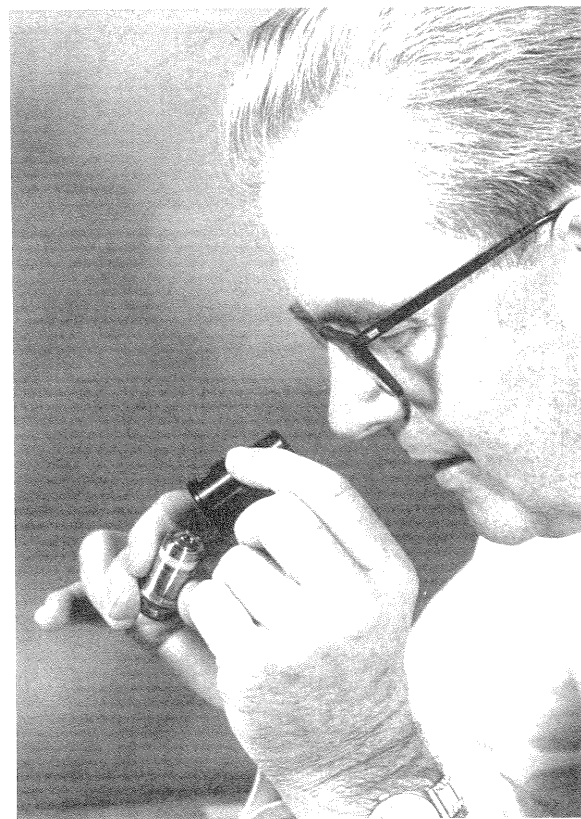

Objective and eyepieces are carefully aligned at the factory and must not be taken apart. Entrust this type of work only to authorized AO Reichert Instrument Division service dealers or our factory Customer Service Department.

The Mirror, In-base Illuminator and Condenser are not very sensitive to the presence of dirt. It makes sense, nevertheless, that good housekeeping be exercised on these parts and that they be kept reasonably clean by following the above cleaning methods.

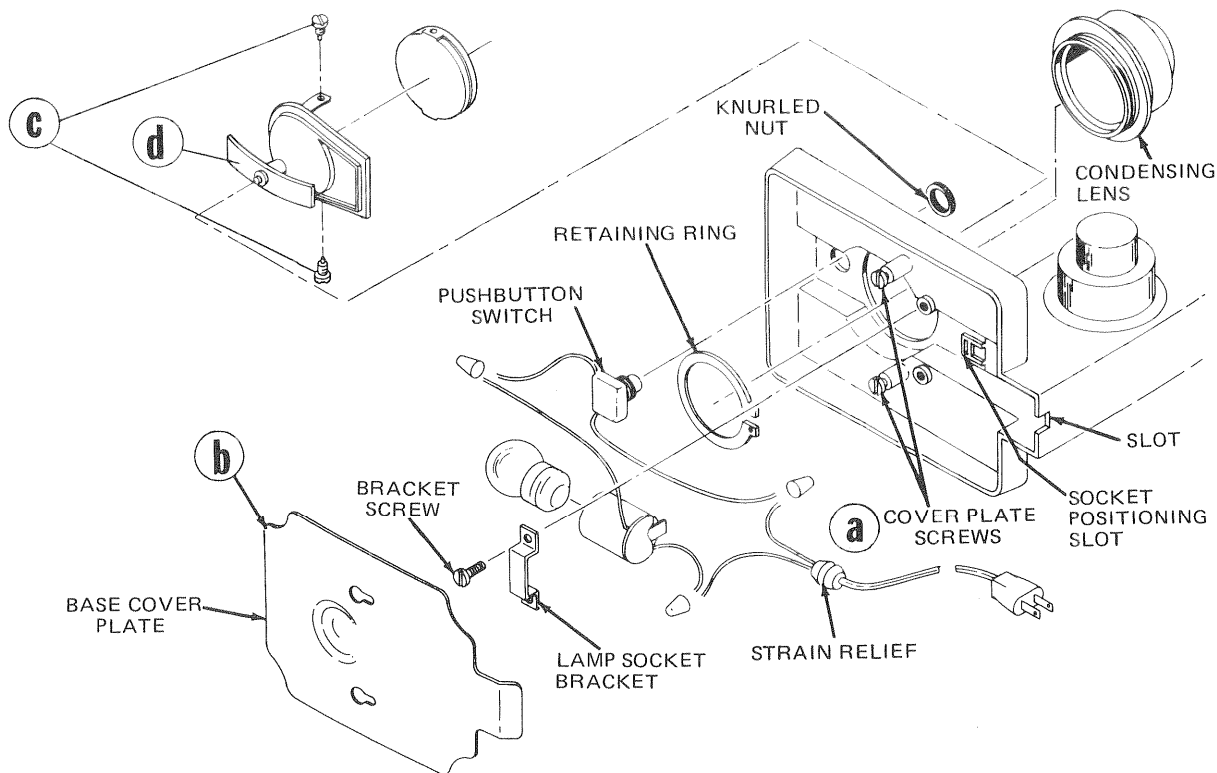

MODELS 614A, 605B IN-BASE ILLUMINATORS

Model 614A, with ground glass condensing lens, is designed specifically for use with Series 150M monocular models.

Model 605B, with aspheric, clear glass condensing lens, is designed for use with Series 150B binocular models.

To mount the illuminator:

1. Place condensing lens assembly on top of microscope base and hold in place from below using the retaining ring.
2. Insert the metal post at rear of lamp socket into the positioning slot in microscope base. The socket is held in place by a metal bracket and two self-threading screws.
3. Mount the push button switch in the small hole located at top front of base. Unscrew

knurled nut, push switch through hole from underside of base and replace knurled nut.

4. Place strain relief of power cord into slot at rear of base.
5. Screw bulb into socket.
6. Attach the one-piece base cover plate and chromed reflector and plug directly into any standard 110-115 volt outlet.

CAUTION

To replace lamp bulb: **DISCONNECT CORD FROM OUTLET.** Carefully place the microscope on its side, remove screws (a) and base cover plate (b), unscrew bulb. For maximum efficiency always replace with same type bulb (manufacturer's designation, 15S11/102) available at any electrical retail outlet.

MODEL 623 IN-BASE ILLUMINATOR, WITH BUILT-IN TRANSFORMER

This Low-Voltage Illuminator equipped with Continuously Variable Transformer is available for use with Series One-Fifty Binocular Models only, for situations requiring greater light intensity.

Model 623 consists of: No. 623-854 Transformer, Power Cord, Variable Voltage Control and Ceramic Socket Assembly; No. 623-18 Socket Mounting Plate; No. 623-24 Intensity Indicator Plate; No. 623-25 Transformer Control Knob; No. 623-856 Condensing Lens Assembly; No. 623-14 Base Cover Plate; No. 624 Lamp (Philips 7387) and eight screws.

If you order a Series L150 Microscope the 623 Illuminator will be installed at the factory. If the illuminator is purchased separately it must be installed as follows:

1. Carefully place microscope on its side and remove cover plate. Remove existing mirror or illuminator.
2. Insert strain relief of power cord into slot at rear of microscope base.
3. Use the two shorter self-threading screws (supplied) to attach the transformer to the two lugs located on the under side of microscope base closest to the rear of base.
4. Attach ceramic socket to socket mounting plate using the two short straight screws supplied.
5. Insert condensing lens assembly into top of microscope base. **BE SURE RECESSED SHOULDERS ARE PARALLEL WITH FRONT END OF BASE.** Attach socket mounting plate to lens housing using the two long straight screws supplied. Make sure the intensity control wires run under mounting plate.

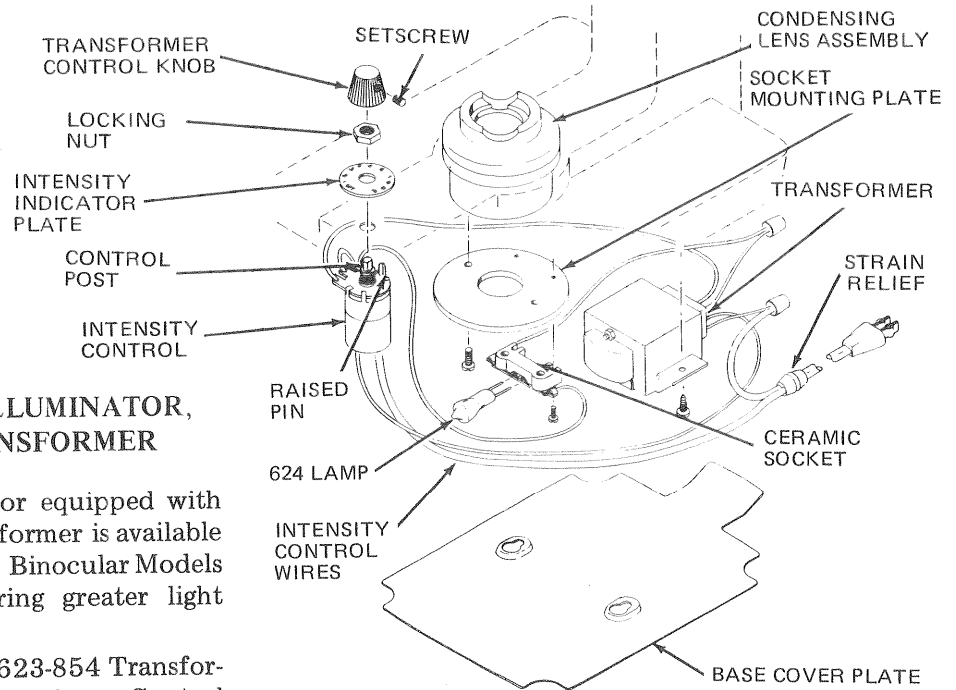

6. The combination "on-off" switch and variable intensity control is mounted in the small hole at top front of microscope base. Remove locking nut from control assembly and mount switch from under side of base making sure the raised pin on switch housing is placed into the positioning hole. The intensity indicator plate is backed with cement that is activated by adding a few drops of solvent such as acetone or xylene. Attach indicator plate with "OFF" towards front of microscope base and in line with the center of control post. Re-attach locking nut to hold switch in place.
7. Rotate switch control post clockwise so the flat side of post is facing front of microscope base.
8. Attach transformer control knob so that setscrew faces flat side of post. Tighten setscrew. Rotate control knob counter-clockwise as far as possible. This is the "OFF" position.
9. Insert No. 624 tungsten halogen lamp 6V, 10 watt (Philips No. 7387) into socket and attach base cover plate.
10. Plug directly into any standard 115 volt, 60 Hz AC outlet.

When operating illuminator the control knob should be set at the most comfortable viewing level. Settings of 1 through 10 are provided.