

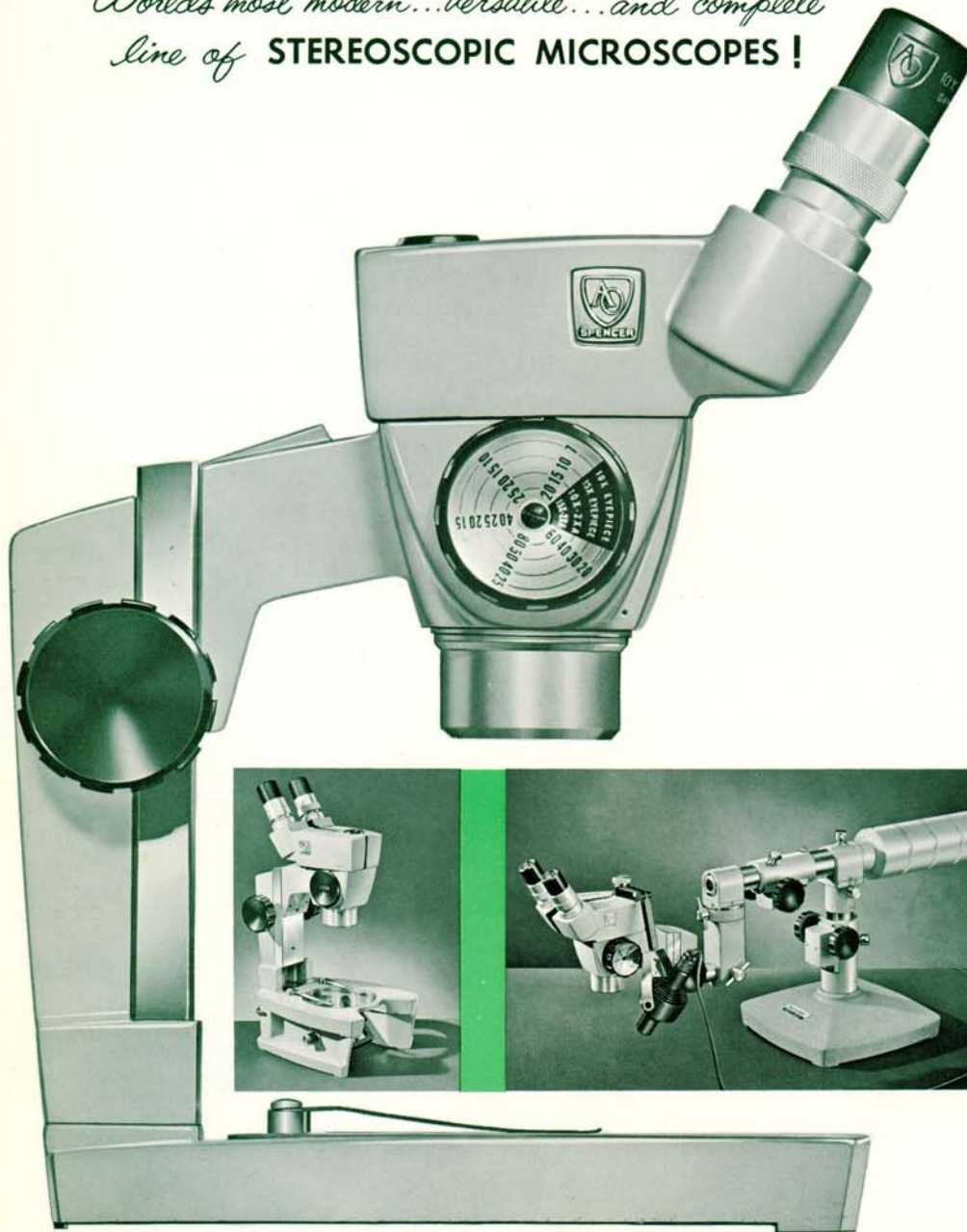

SPENCER

# CYCLOPTIC

*World's most modern...versatile...and complete  
line of* **STEREOSCOPIC MICROSCOPES!**



AMERICAN OPTICAL COMPANY • INSTRUMENT DIVISION • BUFFALO 15, NEW YORK



SPENCER

# CYCLOPTIC

1. One of many lines of skilled operators employing CYCLOPTIC Microscopes to assemble advanced germanium computer transistors at Texas Instruments Semiconductor—Components Division, Dallas, Texas.

2. High school student using CYCLOPTIC to observe Infusoria culture. 3-dimensional magnification permits quick, easy selection and isolation of desired protozoa.

3. Technician at IBM Research and Development Laboratories, Poughkeepsie, N. Y. uses CYCLOPTIC Microscope while forming tiny transistor lead wires.

4. CYCLOPTIC used in Embryology Laboratory to observe chick embryo development under crisp 3-dimensional magnification.

5. Three Western Electric engineers working on a transistor problem with the help of an AO Spencer CYCLOPTIC Series 53M.

Newest RCA development, thimble-size electron tube, assembled with the aid of an AO Spencer CYCLOPTIC Stereoscopic Microscope.

*Widely used...*



1



2



3

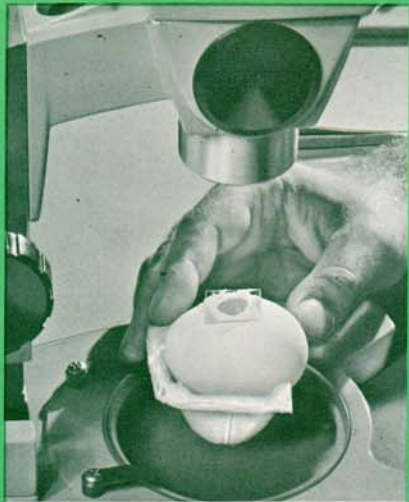

4

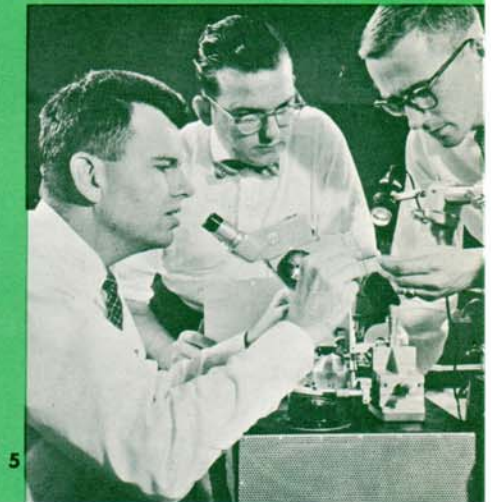

5

**IN INDUSTRY, EDUCATION AND RESEARCH -**

**a model to suit every application**



# CYCLOPTIC MICROSCOPES

Outstanding features . . . plus . . .

1. Reversible and inclined body
2. Long working distance
3. Large field of view
4. Wide range of magnifications
5. Erected and unreversed image
6. Top quality optics . . . low reflection coated
7. Enhanced stereoscopic view
8. Adjustable for interpupillary and eye-refraction differences
9. Rigid, well balanced stands
10. Advanced styling and design
11. Dove-gray EPOXY finish

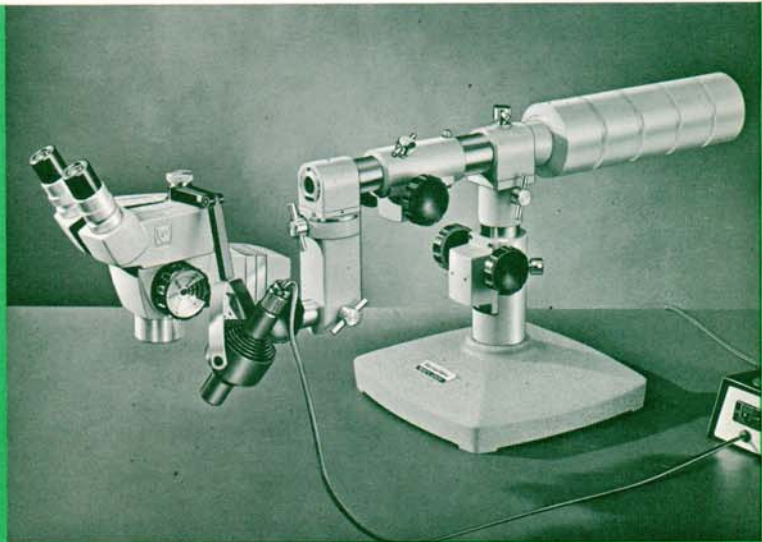

Cycloptic Series 53



Cycloptic Series 56



Cycloptic Series 58

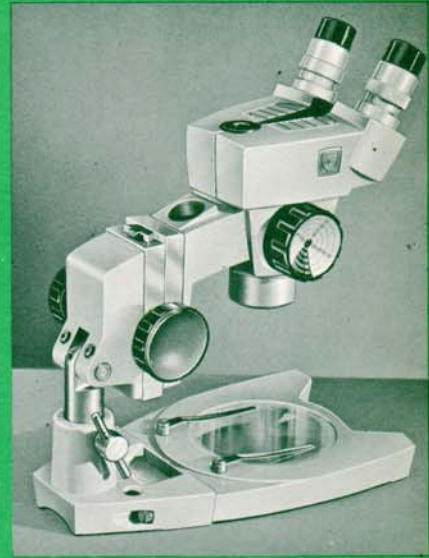

Cycloptic Series 59

*Broad selection of models  
gives unmatched versatility!*

the revolutionary

**MAGNI-***Changer*



Magni-Changer "J"

Magni-Changer "K"

Magni-Changer "M"

### Magnifications Simply "Dialed-In"

Only the AO CYCLOPTIC offers the convenient Magni-Changer. Desired magnification can be selectively "dialed-in" by simple rotation of the Magni-Changer to indicated values. Three Magni-Changer models . . . "J," "K" and "M" . . . are available.

#### Magni-Changers "J" and "K"!

Contain 8 achromatically corrected optical elements . . . offer three different magnifications for each eyepiece-objective combination.

#### Magni-Changer "M"!

Contains 16 achromatically corrected optical elements . . . offers five different

magnifications for each eyepiece-objective combination.

Intermediate magnifications are conveniently obtainable on "J," "K" and "M" models by rotation of the Magni-Changer, insertion of other powered eyepieces or substitution of basic objectives and auxiliary lens-attachments.

#### Fixed Body Magnifications!

Model F CYCLOPTICS are supplied with a fixed body magnification and resultant magnifications can be varied by substitution and addition of eyepieces, objectives, or auxiliary lens-attachments.





## REVERSIBLE and INCLINED BODIES

Binocular bodies are readily reversible to suit user preference . . . inclined at optimum angle of 30° from vertical for comfort . . . and adjustable for interpupillary distances 48mm to 78mm. One of the eyepiece tubes is adjustable for correction of eye-refraction differences. Each body section houses a securely mounted one-piece prism sealed against moisture and foreign particles.



### BUILT TO TAKE IT!

Stroboscopic photograph shows "permanent" mounted prism being crashed into solid piece of wood. Bond was not affected in any way and demonstrates the amazing holding power of specially developed "permanent" bonding agent used to mount prisms in CYCLOPTIC Microscopes. CYCLOPTIC can be put to extreme use . . . mounted on vibrating production machine, rough and tumble field trips, student handling . . . and can be cleaned frequently and easily with same positive, permanent prism alignment assured.



## BROAD SELECTION OF RIGID WELL-BALANCED STANDS

The stands—the structural units which support all optical components and adjustments—are rigid and well balanced for stability . . . withstand hard usage and handling . . . and insure lasting optical alignment. Adjustment controls are rationally positioned for fatigue-free operation. A wide selection of microscope stands is offered to meet your requirements.

**NEW EPOXY FINISH**—Remarkably smooth, durable . . . EPOXY . . . unequalled for resistance to chemicals, abrasion and mechanical impact. Pleasing dove-gray color.

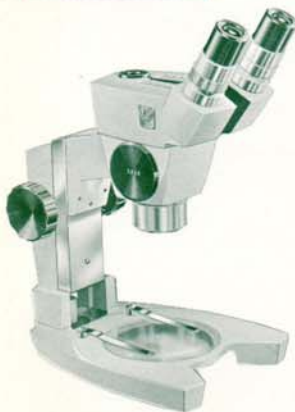

56F-1

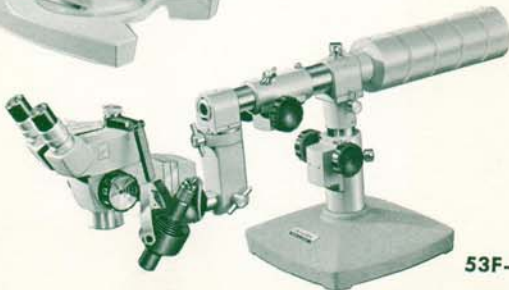

53F-1



58M-1

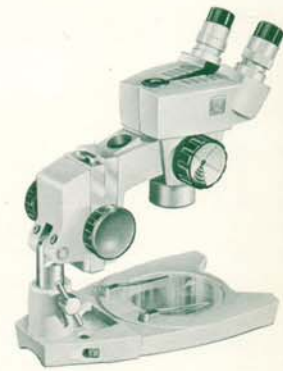

59K-1

### ADJUSTABLE TENSION

Tension on focusing control knobs conveniently adjustable to suit individual touch or to compensate for normal wear over period of years. To increase tension, hold one knob firmly and turn opposite knob clockwise . . . counterclockwise turn loosens tension.



## WIDE FIELD EYEPIECES

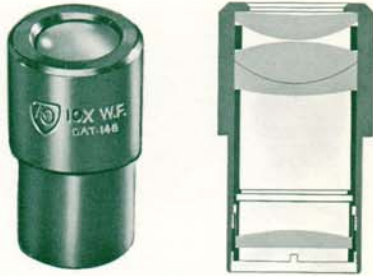

Completely new four-optical-element wide field eyepieces offer superior image quality . . . wide field of view . . . full chromatic, curvature and distortion correction . . . comfortable eye relief even for eyeglass wearers. Micrometer disc or reticle can be conveniently inserted into eyepieces. 10X, 15X and 20X eyepieces are available.



## APOCHROMATIC OBJECTIVES

Three special wide angle high quality objectives have been designed for the CYCLOPTIC Series Microscopes. These three-lens apochromats are superbly corrected for chromatic and spherical aberrations . . . present a crisp, true enhanced stereoscopic image over the full field of view.



## ACHROMATIC AUXILIARY LENS-ATTACHMENTS



Three achromatically corrected auxiliary lens-attachments are available . . . readily attachable to the basic objective...and extend the useful range of magnifications.

## LONG WORKING DISTANCES

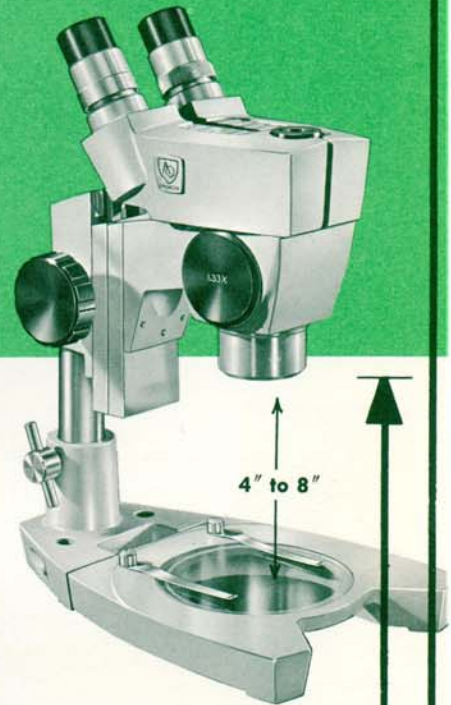

Standard CYCLOPTIC Microscopes provide remarkable constant long working distance of 4" between specimen and objective; an extraordinary long working distance of 8" is attainable by use of 1/2X objective and is available on CYCLOPTIC Series 53, 55, 59. Special 1/3X objective will provide 12.5" working distance with CYCLOPTIC Series 53, 55. These unusually long working distances permit efficient illumination and effective manipulation of specimens.





# CYCLOSPOT, VERTICAL ILLUMINATOR



The new CYCLOSPOT is outstanding for epi- and trans-illumination . . . may be efficiently used in five different positions . . . includes two-element condenser system, fixed transformer . . . detachable universal arm . . . and 6.5V, 2.75 amp lamp.

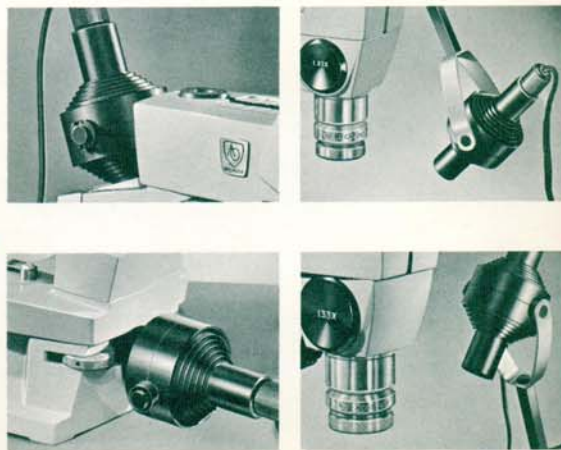

Cross section illustrates lamp, first surfaced spherical mirrors and pre-focused two-lens projection system. Yoke permits easy and quick positioning of light beam and unique venting assures cool operation.

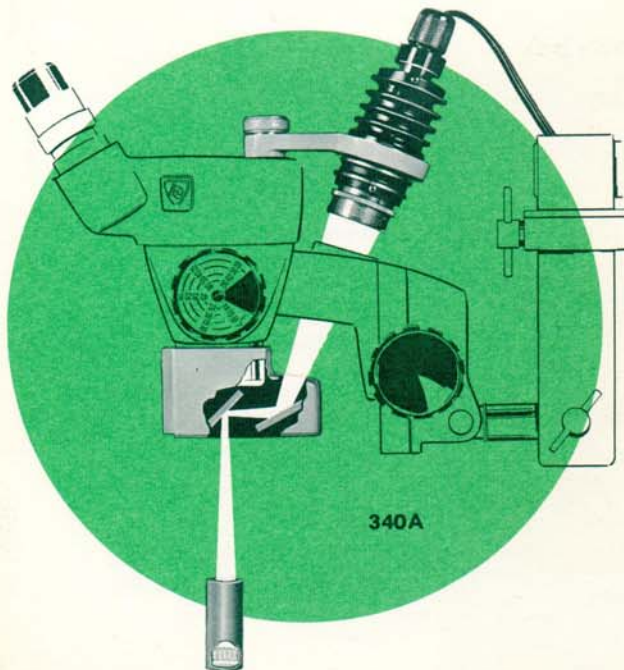

The new Vertical Illuminator permits examination of deep orifices where the angle is too acute for oblique illumination methods. This illuminator extends the advantages of stereoscopic microscopy to a great variety of new problems ranging from the inspection of small I.D. borings in machined parts or castings to delicate ear surgery. It consists of a lamphouse with special bracket and hinge pin for attachment to CYCLOPTIC stand; a vertical reflector that mounts over objective or auxiliary lens attachment; and a variable transformer. A multiple lens focusing system permits you to critically focus the intense light to match the working distances of the standard objective, the 2/3X auxiliary lens attachment, and the 1/2X and 1/3X special long working distance objectives.





## and FLUORESCENT ILLUMINATOR

### 640 Series

The versatile new AO Spencer Fluorescent Illuminators are specifically designed for use with the AO Spencer Cycloptic and Stereoscopic Series low-power microscopes.

Two daylight fluorescent tubes . . . #F4T5/D . . . provide a flat, diffused, cool light that floods over the gross specimen to evenly illuminate surface detail regardless of specimen thickness variations. The Kelvin rating of approximately 6500° approaches true daylight . . . makes it ideal for use with Cycloptic and No. 637 Stereocamera . . . allows use of standard outdoor color film without filters. Black light tubes, #F4T5/BLB, and green light tubes, #F4T5/G, can also be used.\*

\*Black light tubes, green light tubes and replacement daylight tubes are readily available through electrical supply stores or dealers, and are not sold or stocked by American Optical Company.



**AO Spencer Fluorescent Illuminator No. 640A** consists of No. 640 Fluorescent Illuminator and No. 642 Jackknife Arm and Base. The adjustable Jackknife Arm, equipped with a pin, locks into the heavy base for use as an independent light source or into a socket on body of AO Spencer Stereoscopic Microscopes, Series 20, 21, 23, 25, 26, 27 and 28.



**AO Spencer Fluorescent Illuminator No. 640** is attachable directly to the Cycloptic standard objective or to the 2X Auxiliary Lens-Attachment . . . provides full-field illumination either in to-and-fro or left-to-right positions . . . convenient thumb lock-screw holds it securely in desired position.



# Model 638 AO PHOTOGRAPHIC TUBE ADAPTER FOR CYCLOPTIC MICROSCOPES

A valuable aid to the use of the Cycloptic Stereoscopic Microscope is the new Model 638 Photographic Tube Adapter. It makes available for the first time a means of obtaining quick photomicrographs through the use of the AO Series 682 Cameras and similar photomicrographic equipment on the market.

The Polaroid® Land Camera Back is the ideal application since it offers immediate photographic results.

While this Single Tube Adapter has been designed specifically for use with AO Spencer Series 682 Camera, it can be successfully used with other equipment.

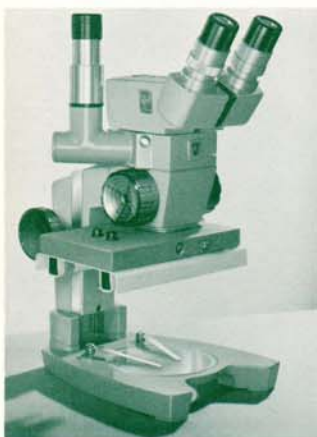
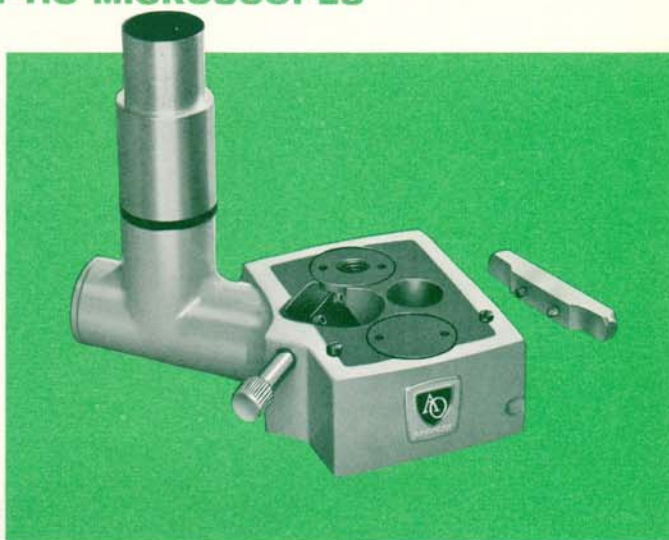

Single Tube Adapter is quickly attached to Cycloptic Microscope. Shown with No. 640 Illuminator and No. 146 Eyepiece.



Ideal photographic application utilizes No. 682G Camera with Polaroid Land Camera back. This offers "picture in ten seconds" results.

### Rapid, Easy Attachment

The entire assembly can be quickly attached to any model Cycloptic Microscope in less than a minute. Focusing is accomplished through the conventional binocular portion of the microscope. A flip-out mirror then diverts the light from one tube of the binocular body to the Single Tube Adapter.

### Fluorescent Illuminator

A recommended source of illumination for many types of work is the AO Fluorescent Illuminator, No. 640, which provides a flat, diffused, cool light that floods uniformly over the full field to evenly illuminate surface detail. The No. 640 attaches directly to the standard Cycloptic objective or to the Auxiliary Lens Attachments (except No. 264).

For special problems, other types of illumination will provide excellent results. A source of high intense light is the No. 653 Universal Illuminator, with its three-lens focusable condensing system.

CATALOG NO.	DESCRIPTION
638	Single Photographic Tube Adapter for Cycloptic Microscopes. (Does not include eyepiece.)
640	Fluorescent Illuminator with lock-screw for attachment to Cycloptic; complete with cord and plug.
653	Universal Microscope Illuminator with three-













CATALOG NO.	DESCRIPTION
146	10X Wide Field eyepiece
147	15X Wide Field eyepiece
682G	Photomicrographic Camera with Polaroid Back

# Easy-to-follow CYCLOPTIC MICROSCOPE CODE

For example: Model 58M-T3

58 = 58 basic stand  
M = Magni-Changer "M"

T = 2/3X Auxiliary Lens-Attachment  
3 = 10X and 15X Wide Field Eyepieces

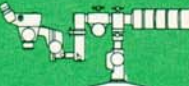
Basic Stand	Body Magnification	Auxiliary Lens-Attachment	Eyepieces
56 	<b>F</b>  Fixed Body Magnification with standard objective		1  10X Wide Field
58 	<b>J</b>  MAGNI-CHANGER with standard objective	<b>HYPHEN</b> <b>T</b>  2/3X	2  15X Wide Field
59 	<b>K</b>  MAGNI-CHANGER with standard objective		
55 	<b>M</b>  MAGNI-CHANGER with standard objective	<b>D</b>  2X	3  10X Wide Field and 15X Wide Field
53 			



Basic Stand	Body Magnification	Eyepieces
<b>SPECIAL LONG WORKING DISTANCE COMBINATIONS</b> available on series 53, 55 and 59 only.	53 <b>FL</b>  Fixed Body Magnification with Special 1/2X objective	1  10X Wide Field
	55 <b>JL</b>  MAGNI-CHANGER with Special 1/2X objective	<b>HYPHEN</b> 2  15X Wide Field
	59 <b>KL</b>  MAGNI-CHANGER with Special 1/2X objective	
	<b>ML</b>  MAGNI-CHANGER with Special 1/2X objective	

TABLE OF RESULTANT MAGNIFICATIONS, FIELDS OF VIEW AND WORKING DISTANCES

FIXED BODY "F" AND MAGNI-CHANGER "J," "K," "M"  
VARIABLE BODY MAGNIFICATIONS—with Standard Objective

Eyepiece	Auxiliary Lens-Attachment	Magnification				Field of View*	Working Distance*
		"F"	"J"	"K"	"M"		
10X	—	—	7X	—	7X	1.20"	4.0"
	—	—	10X	—	10X	0.90	
	—	15X	15X	15X	15X	0.60	
	—	—	—	20X	20X	0.40	
	—	—	—	25X	25X	0.30	
15X	—	—	10X	—	10X	1.00"	4.0"
	—	—	—	15X	15X	0.75	
	—	20X	20X	20X	20X	0.50	
	—	—	—	30X	30X	0.33	
	—	—	—	40X	40X	0.25	
10X	2X	—	15X	—	15X	0.60"	1.5"
		—	—	20X	20X	0.45	
		25X	25X	25X	25X	0.30	
		—	—	40X	40X	0.20	
		—	—	50X	50X	0.15	
15X	2X	—	20X	—	20X	0.50"	1.5"
		—	—	25X	25X	0.37	
		40X	40X	40X	40X	0.25	
		—	—	60X	60X	0.17	
		—	—	80X	80X	0.13	
10X	2/3X	—	4.5X	—	4.5X	1.75"	4.4"
		—	—	6X	6X	1.33	
		10X	10X	10X	10X	0.90	

(CONTINUED)

10X	2/3X	—	18X	15X	15X	0.60"	4.4"
15X	2/3X	—	7X	—	7X	1.50"	4.4"
		—	—	10X	10X	1.12	
		15X	15X	15X	15X	.75	
		—	—	20X	20X	.50	
		—	—	25X	25X	.37	

SPECIAL LONG WORKING DISTANCE COMBINATIONS FOR CYCLOPTIC SERIES 53, 55, 59 ONLY

FIXED BODY "F" AND "J," "K," "M"  
VARIABLE BODY MAGNIFICATIONS—Special 1/2X Objective

		"FL"	"JL"	"KL"	"ML"		
10X	—	—	3.5X	—	3.5X	2.40"	8.0"
	—	—	—	5X	5X	1.80	
	—	7X	7X	7X	7X	1.20	
	—	—	—	10X	10X	0.80	
	—	—	15X	—	15X	0.60	
15X	—	—	5X	—	5X	2.00"	8.0"
	—	—	—	7X	7X	1.50	
	—	10X	10X	10X	10X	1.00	
	—	—	—	15X	15X	0.66	
	—	—	20X	—	20X	0.50	

\*To convert inch values to millimeters: multiply by 25.4



# CYCLOPTIC

## MICROSCOPE...SERIES 53

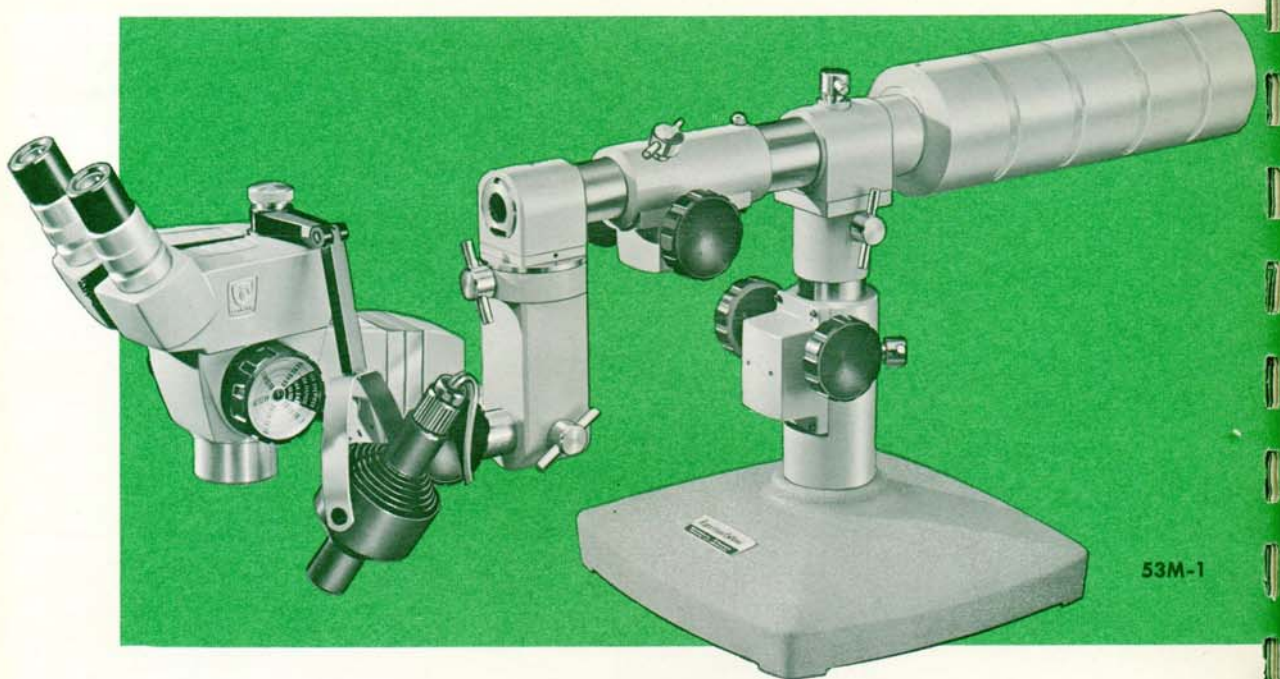

### UNIVERSAL TABLE STAND

*... widest range  
of adjustments ever offered!*

CYCLOPTIC MICROSCOPE Series 53F, 53J, 53K and 53M are supplied with inclined, reversible binocular bodies; standard apochromatic objective or special long working distance 1/2X apochromatic objective as selected; eyepieces and auxiliary lens-attachments as selected; wide, durable, diagonally-cut rack and pinion focusing and positioning adjustments; large universal table stand.

CYCLOPTIC MICROSCOPE Series 53F has a fixed body magnification of 1.33X.

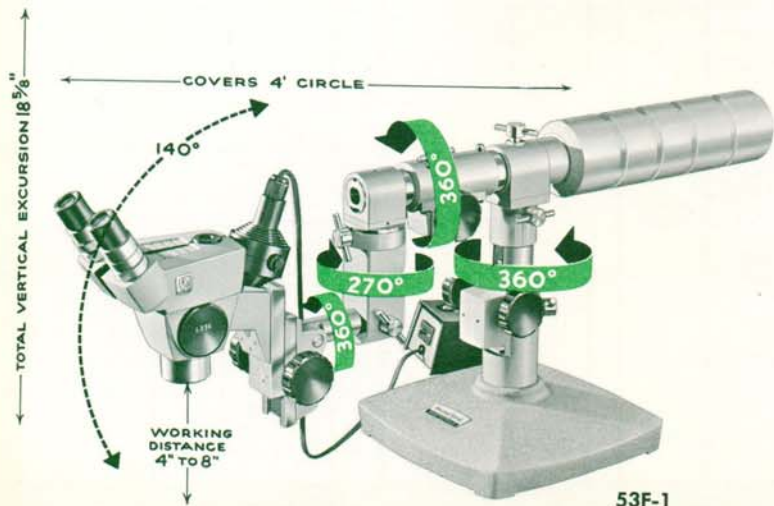

53F-1

CYCLOPTIC MICROSCOPE Series 53J and 53K are equipped with Magni-Changer "J" and "K" respectively, offering selection of three body magnifications; Series 53M is equipped with Magni-Changer "M," offering selection of five body magnifications. Resultant magnifications are indexed on the positioning dials.

A wide selection of CYCLOPTIC MICROSCOPES Series 53F, 53J, 53K and 53M is available to satisfy your specific needs. Illustrated models 53M-1 and 53F-1 . . . and tabulation of additional models on page 13 are presented to simplify your final selection.

# AO SPENCER CYCLOPTIC SERIES 53F, 53J, 53K and 53M

## SERIES 53F



Catalog Number	Body Magnification	Auxiliary Lens-Attachment	Eyepieces Wide Field	Magnifications	Working Distance
53F-1	Fixed "F"	—	10X	15X	4"
53F-2	Fixed "F"	—	15X	20X	4"
53F-3	Fixed "F"	—	10X, 15X	15X, 20X	4"
53F-D1	Fixed "F"	2X	10X	15X, 25X	1.5", 4"
53F-D2	Fixed "F"	2X	15X	20X, 40X	1.5", 4"
53F-T1	Fixed "F"	2/3X	10X	10X, 15X	4", 4.4"

## SERIES 53J



53J-1	Magni-Changer "J"	—	10X	7X, 15X, 25X	4"
53J-2	Magni-Changer "J"	—	15X	10X, 20X, 40X	4"
53J-D1	Magni-Changer "J"	2X	10X	7X, 15X, 25X, 50X	1.5", 4"
53J-D2	Magni-Changer "J"	2X	15X	10X, 20X, 40X, 80X	1.5", 4"
53J-T1	Magni-Changer "J"	2/3X	10X	4.5X, 7X, 10X, 15X, 18X, 25X	4", 4.4"

## SERIES 53K



53K-1	Magni-Changer "K"	—	10X	10X, 15X, 20X	4"
53K-2	Magni-Changer "K"	—	15X	15X, 20X, 30X	4"
53K-D1	Magni-Changer "K"	2X	10X	10X, 15X, 20X, 25X, 40X	1.5", 4"
53K-D2	Magni-Changer "K"	2X	15X	15X, 20X, 25X, 30X, 40X, 60X	1.5", 4"
53K-T1	Magni-Changer "K"	2/3X	10X	6X, 10X, 15X, 20X	4", 4.4"

## SERIES 53M



53M-1	Magni-Changer "M"	—	10X	7X, 10X, 15X, 20X, 25X	4"
53M-2	Magni-Changer "M"	—	15X	10X, 15X, 20X, 30X, 40X	4"
53M-3	Magni-Changer "M"	—	10X, 15X	7X, 10X, 15X, 20X, 25X, 30X, 40X	4"
53M-D1	Magni-Changer "M"	2X	10X	7X, 10X, 15X, 20X, 25X, 40X, 50X	1.5", 4"
53M-D2	Magni-Changer "M"	2X	15X	10X, 15X, 20X, 25X, 30X, 40X, 60X, 80X	1.5", 4"
53M-D3	Magni-Changer "M"	2X	10X, 15X	7X, 10X, 15X, 20X, 25X, 30X, 40X, 50X, 60X, 80X	1.5", 4"
53M-T1	Magni-Changer "M"	2/3X	10X	4.5X, 6X, 7X, 10X, 15X, 18X, 20X, 25X	4", 4.4"

## SPECIAL LONG WORKING DISTANCE COMBINATIONS

53FL-1	Special: Fixed "F"/2	—	10X	7.5X	8"
53FL-2	Special: Fixed "F"/2	—	15X	10X	8"
53JL-1	Magni-Changer "J" and 1/2X Objective	—	10X	3.5X, 7X, 15X	8"
53JL-2	Magni-Changer "J" and 1/2X Objective	—	15X	5X, 10X, 20X	8"
53KL-1	Magni-Changer "K" and 1/2X Objective	—	10X	5X, 7.5X, 10X	8"
53KL-2	Magni-Changer "K" and 1/2X Objective	—	15X	7X, 10X, 15X	8"
53ML-1	Magni-Changer "M" and 1/2X Objective	—	10X	3.5X, 5X, 7.5X, 10X, 12.5X	8"
53ML-2	Magni-Changer "M" and 1/2X Objective	—	15X	5X, 7.5X, 10X, 15X, 20X	8"

Cabinets are not available for CYCLOPTIC Series 53F, 53J, 53K, and 53M.

NOTE: No. 1157 20X Wide Field eyepieces are available for use with Series 53 and may be substituted at no increase in cost.



# CYCLOPTIC

## MICROSCOPE . . . SERIES 56

CYCLOPTIC MICROSCOPE Series 56F, 56J, 56K and 56M are supplied with inclined, reversible binocular bodies; standard apochromatic objective; eyepieces and auxiliary lens-attachments as selected; wide, durable, diagonally-cut rack and pinion focusing adjustment . . . adjustable tension; heavy duty slideways . . . extra long excursion; standard base-stage with glass insert and stage clips.

CYCLOPTIC MICROSCOPE Series 56F has a fixed body magnification of 1.33X.

CYCLOPTIC MICROSCOPE Series 56J and 56K are equipped with Magni-Changer "J" and "K" respectively, offering selection of three body magnifications; Series 56M is equipped with Magni-Changer "M," offering selection of five body magnifications. Resultant magnifications are indexed on the positioning dials.

Series 56F, 56J, 56K and 56M are convertible to Series 58F, 58J, 58K and 58M by addition of 58S base.

A wide selection of CYCLOPTIC MICROSCOPE Series 56F, 56J, 56K and 56M is available to satisfy your specific needs. Illustrated models 56F-1, 56M-1 and 56K-1 . . . and tabulation of additional models on page 15 are presented to simplify your final selection.

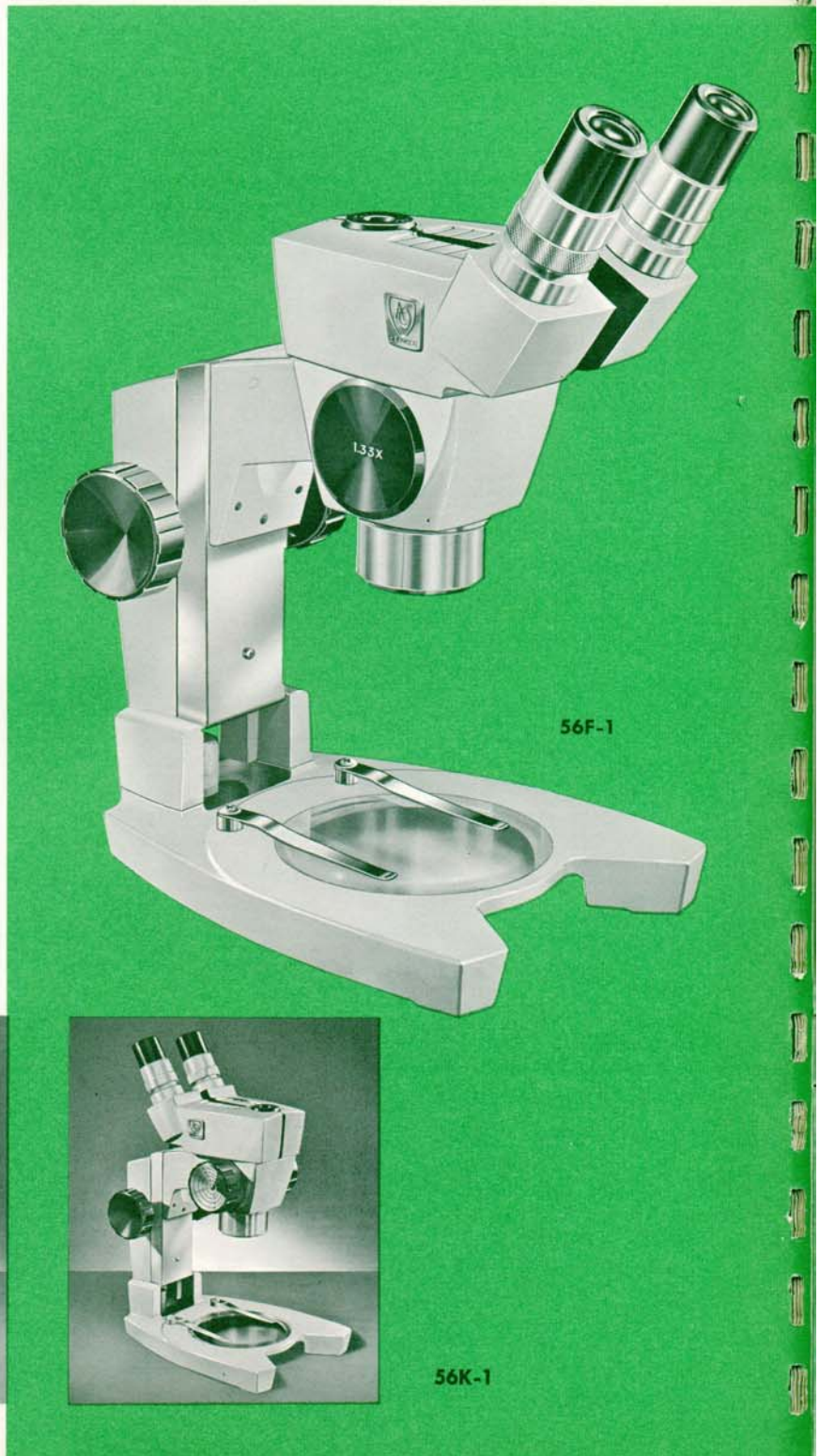

# AO SPENCER CYCLOPTIC SERIES 56F, 56J, 56K and 56M

Catalog Number	Body Magnification	Auxiliary Lens-Attachment	Eyepieces Wide Field	Magnifications	Working Distance
<b>SERIES 56F</b>					
56F-1	Fixed "F"	—	10X	15X	4"
56F-2	Fixed "F"	—	15X	20X	4"
56F-3	Fixed "F"	—	10X, 15X	15X, 20X	4"
56F-D1	Fixed "F"	2X	10X	15X, 25X	1.5", 4"
56F-D2	Fixed "F"	2X	15X	20X, 40X	1.5", 4"
56F-T1	Fixed "F"	2/3X	10X	10X, 15X	4", 4.4"
<b>SERIES 56J</b>					
56J-1	Magni-Changer "J"	—	10X	7X, 15X, 25X	4"
56J-2	Magni-Changer "J"	—	15X	10X, 20X, 40X	4"
56J-D1	Magni-Changer "J"	2X	10X	7X, 15X, 25X, 50X	1.5", 4"
56J-D2	Magni-Changer "J"	2X	15X	10X, 20X, 40X, 80X	1.5", 4"
56J-D3	Magni-Changer "J"	2X	10X, 15X	7X, 10X, 15X, 20X, 25X, 40X, 50X, 80X	1.5", 4"
56J-T1	Magni-Changer "J"	2/3X	10X	4.5X, 7X, 10X, 15X, 18X, 25X	4", 4.4"
<b>SERIES 56K</b>					
56K-1	Magni-Changer "K"	—	10X	10X, 15X, 20X	4"
56K-2	Magni-Changer "K"	—	15X	15X, 20X, 30X	4"
56K-D1	Magni-Changer "K"	2X	10X	10X, 15X, 20X, 25X, 40X	1.5", 4"
56K-D2	Magni-Changer "K"	2X	15X	15X, 20X, 25X, 30X, 40X, 60X	1.5", 4"
56K-T1	Magni-Changer "K"	2/3X	10X	6X, 10X, 15X, 20X	4", 4.4"
<b>SERIES 56M</b>					
56M-1	Magni-Changer "M"	—	10X	7X, 10X, 15X, 20X, 25X	4"
56M-2	Magni-Changer "M"	—	15X	10X, 15X, 20X, 30X, 40X	4"
56M-3	Magni-Changer "M"	—	10X, 15X	7X, 10X, 15X, 20X, 25X, 30X, 40X	4"
56M-D1	Magni-Changer "M"	2X	10X	7X, 10X, 15X, 20X, 25X, 40X, 50X	1.5", 4"
56M-D2	Magni-Changer "M"	2X	15X	10X, 15X, 20X, 25X, 30X, 40X, 60X, 80X	1.5", 4"
56M-D3	Magni-Changer "M"	2X	10X, 15X	7X, 10X, 15X, 20X, 25X, 30X, 40X, 50X, 60X, 80X	1.5", 4"
56M-T1	Magni-Changer "M"	2/3X	10X	4.5X, 6X, 7X, 10X, 15X, 18X, 20X, 25X	4", 4.4"

No. 1656 Cabinet for CYCLOPTIC Microscope Series 56F, 56J, 56K, and 56M, is available at additional cost. See price insert.

NOTE: No. 1157 20X Wide Field eyepieces are available for use with Series 56 and may be substituted at no increase in cost.



# CYCLOPTIC

## MICROSCOPE . . . SERIES 58

CYCLOPTIC MICROSCOPE Series 58F, 58J, 58K and 58M are supplied with inclined, reversible binocular bodies; standard apochromatic objective; eyepieces and auxiliary lens-attachments as selected; wide, durable, diagonally-cut rack and pinion focusing adjustment . . . adjustable tension; heavy duty slideways . . . extra long excursion; standard stage with glass insert and stage clips; detachable transilluminating substage base.

CYCLOPTIC MICROSCOPE Series 58F has a fixed body magnification of 1.33X.

CYCLOPTIC MICROSCOPE Series 58J and 58K are equipped with Magni-Changer "J" and "K" respectively, offering selection of three body magnifications; Series 58M is equipped with Magni-Changer "M," offering selection of five body magnifications. Resultant magnifications are indexed on the positioning dials.

A wide selection of CYCLOPTIC MICROSCOPE Series 58F, 58J, 58K and 58M is available to satisfy your specific needs. Illustrated models 58M-1, 58F-1 and 58J-1 . . . and tabulation of additional models on page 17 are presented to simplify your final selection.

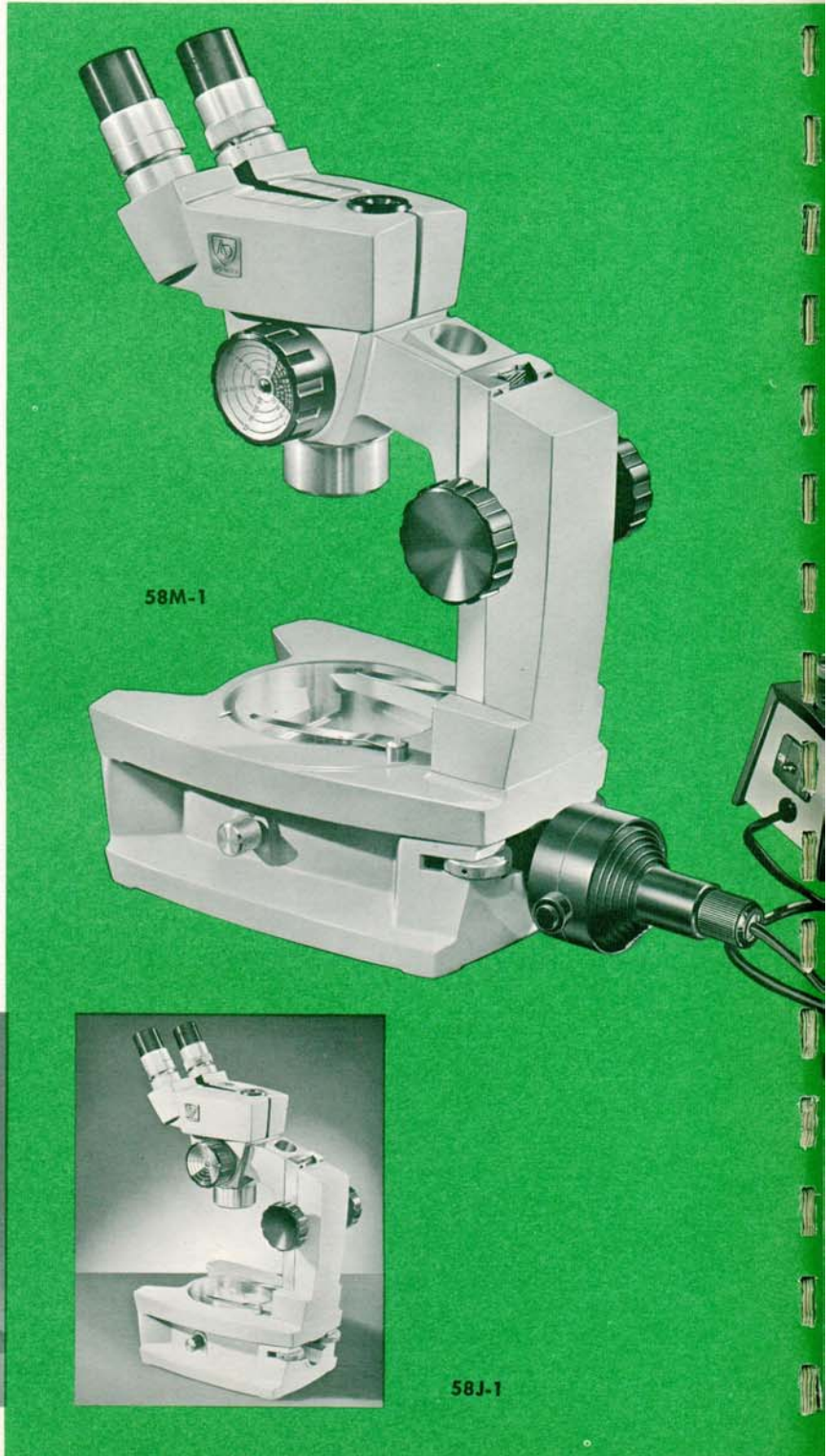

58M-1

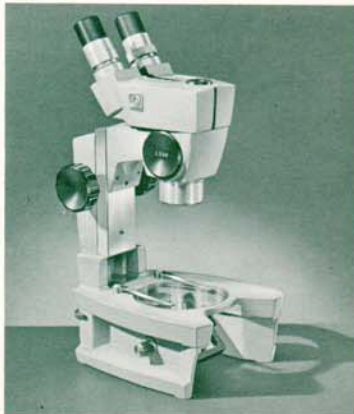





58F-1



58J-1



# AO SPENCER CYCLOPTIC SERIES 58F, 58J, 58K and 58M

Catalog Number	Body Magnification	Auxiliary Lens-Attachment	Eyepieces Wide Field	Magnifications	Working Distance
<b>SERIES 58F</b>					
 58F-1	Fixed "F"	—	10X	15X	4"
58F-2	Fixed "F"	—	15X	20X	4"
58F-3	Fixed "F"	—	10X, 15X	15X, 20X	4"
58F-D1	Fixed "F"	2X	10X	15X, 25X	1.5", 4"
58F-D2	Fixed "F"	2X	15X	20X, 40X	1.5", 4"
58F-T1	Fixed "F"	2/3X	10X	10X, 15X	4", 4.4"
<b>SERIES 58J</b>					
 58J-1	Magni-Changer "J"	—	10X	7X, 15X, 25X	4"
58J-2	Magni-Changer "J"	—	15X	10X, 20X, 40X	4"
58J-D1	Magni-Changer "J"	2X	10X	7X, 15X, 25X, 50X	1.5", 4"
58J-D2	Magni-Changer "J"	2X	15X	10X, 20X, 40X, 80X	1.5", 4"
58J-D3	Magni-Changer "J"	2X	10X, 15X	7X, 10X, 15X, 20X, 25X, 40X, 50X, 80X	1.5", 4"
58J-T1	Magni-Changer "J"	2/3X	10X	4.5X, 7X, 10X, 15X, 18X, 25X	4", 4.4"
<b>SERIES 58K</b>					
 58K-1	Magni-Changer "K"	—	10X	10X, 15X, 20X	4"
58K-2	Magni-Changer "K"	—	15X	15X, 20X, 30X	4"
58K-D1	Magni-Changer "K"	2X	10X	10X, 15X, 20X, 25X, 40X	1.5", 4"
58K-D2	Magni-Changer "K"	2X	15X	15X, 20X, 25X, 30X, 40X, 60X	1.5", 4"
58K-T1	Magni-Changer "K"	2/3X	10X	6X, 10X, 15X, 20X	4", 4.4"
<b>SERIES 58M</b>					
 58M-1	Magni-Changer "M"	—	10X	7X, 10X, 15X, 20X, 25X	4"
58M-2	Magni-Changer "M"	—	15X	10X, 15X, 20X, 30X, 40X	4"
58M-3	Magni-Changer "M"	—	10X, 15X	7X, 10X, 15X, 20X, 25X, 30X, 40X	4"
58M-D1	Magni-Changer "M"	2X	10X	7X, 10X, 15X, 20X, 25X, 40X, 50X	1.5", 4"
58M-D2	Magni-Changer "M"	2X	15X	10X, 15X, 20X, 25X, 30X, 40X, 60X, 80X	1.5", 4"
58M-D3	Magni-Changer "M"	2X	10X, 15X	7X, 10X, 15X, 20X, 25X, 30X, 40X, 50X, 60X, 80X	1.5", 4"
58M-T1	Magni-Changer "M"	2/3X	10X	4.5X, 6X, 7X, 10X, 15X, 18X, 20X, 25X	4", 4.4"

No. 1658 Cabinet for CYCLOPTIC Microscope Series 58F, 58J, 58K, and 58M is available at additional cost. See price insert.

NOTE: No. 1157 20X Wide Field eyepieces are available for use with Series 58 and may be substituted at no increase in cost.



# CYCLOPTIC

## MICROSCOPE . . . SERIES 59

CYCLOPTIC MICROSCOPE Series 59F, 59J, 59K and 59M are supplied with inclined reversible binocular bodies; standard apochromatic objective or special long working distance 1/2X apochromatic objective as selected; eyepieces and auxiliary lens-attachments as selected; wide, durable, diagonally-cut rack and pinion focusing adjustment . . . adjustable tension; heavy duty slideways; yoke and pillar; detachable base-stage with glass insert and stage clips.

CYCLOPTIC MICROSCOPE Series 59F has a fixed body magnification of 1.33X.

CYCLOPTIC MICROSCOPE Series 59J and 59K are equipped with Magni-Changer "J" and "K" respectively, offering selection of three body magnifications; Series 59M is equipped with Magni-Changer "M," offering selection of five body magnifications. Resultant magnifications are indexed on the positioning dials.

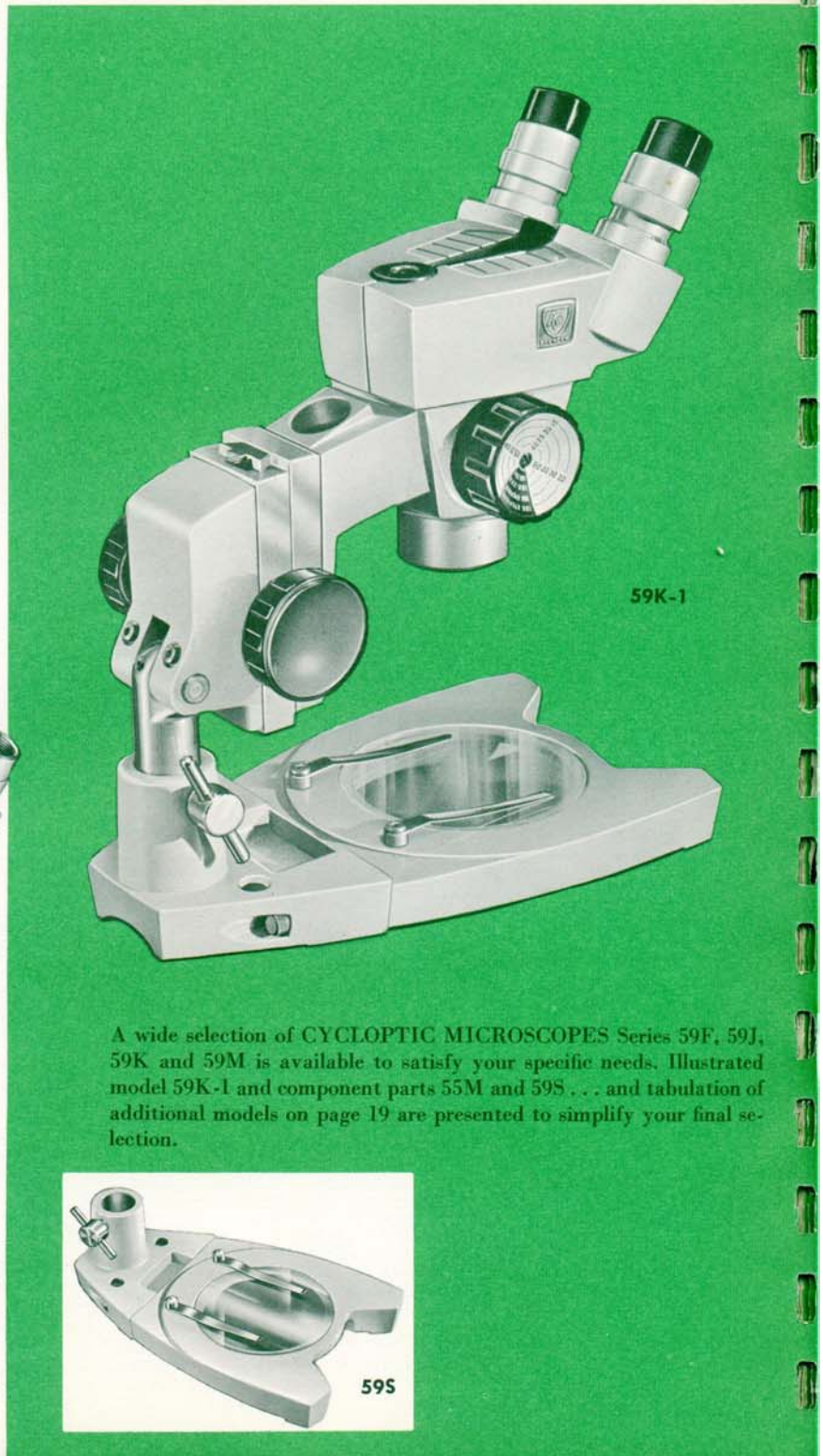

59K-1

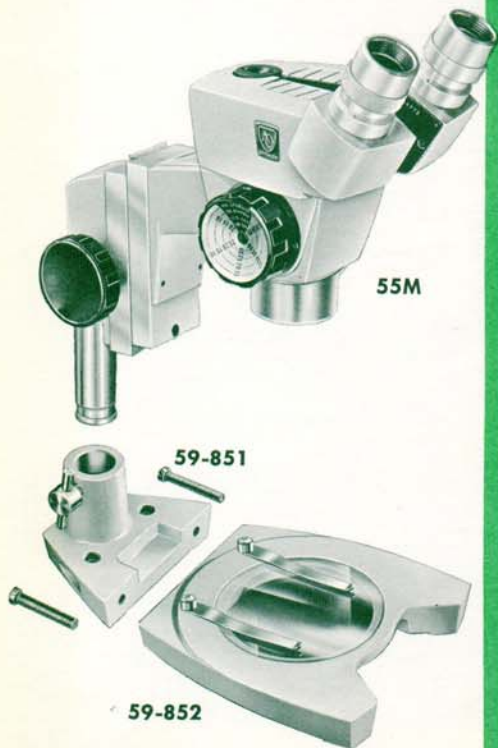

55M

59-851

59-852



59S

A wide selection of CYCLOPTIC MICROSCOPES Series 59F, 59J, 59K and 59M is available to satisfy your specific needs. Illustrated model 59K-1 and component parts 55M and 59S . . . and tabulation of additional models on page 19 are presented to simplify your final selection.

# AO SPENCER CYCLOPTIC SERIES 59F, 59J, 59K and 59M

Catalog Number	Body Magnification	Auxiliary Lens-Attachment	Eyepieces Wide Field	Magnifications	Working Distance
<b>SERIES 59F</b>					
59F-1	Fixed "F"	—	10X	15X	4"
59F-2	Fixed "F"	—	15X	20X	4"
59F-3	Fixed "F"	—	10X, 15X	15X, 20X	4"
59F-D1	Fixed "F"	2X	10X	15X, 25X	1.5", 4"
59F-D2	Fixed "F"	2X	15X	20X, 40X	1.5", 4"
59F-T1	Fixed "F"	2/3X	10X	10X, 15X	4", 4.4"
<b>SERIES 59J</b>					
59J-1	Magni-Changer "J"	—	10X	7X, 15X, 25X	4"
59J-2	Magni-Changer "J"	—	15X	10X, 20X, 40X	4"
59J-D1	Magni-Changer "J"	2X	10X	7X, 15X, 25X, 50X	1.5", 4"
59J-D2	Magni-Changer "J"	2X	15X	10X, 20X, 40X, 80X	1.5", 4"
59J-T1	Magni-Changer "J"	2/3X	10X	4.5X, 7X, 10X, 15X, 18X, 25X	4", 4.4"
<b>SERIES 59K</b>					
59K-1	Magni-Changer "K"	—	10X	10X, 15X, 20X	4"
59K-2	Magni-Changer "K"	—	15X	15X, 20X, 30X	4"
59K-D1	Magni-Changer "K"	2X	10X	10X, 15X, 20X, 25X, 40X	1.5", 4"
59K-D2	Magni-Changer "K"	2X	15X	15X, 20X, 25X, 30X, 40X, 60X	1.5", 4"
59K-T1	Magni-Changer "K"	2/3X	10X	6X, 10X, 15X, 20X	4", 4.4"
<b>SERIES 59M</b>					
59M-1	Magni-Changer "M"	—	10X	7X, 10X, 15X, 20X, 25X	4"
59M-2	Magni-Changer "M"	—	15X	10X, 15X, 20X, 30X, 40X	4"
59M-3	Magni-Changer "M"	—	10X, 15X	7X, 10X, 15X, 20X, 25X, 30X, 40X	4"
59M-D1	Magni-Changer "M"	2X	10X	7X, 10X, 15X, 20X, 25X, 40X, 50X	1.5", 4"
59M-D2	Magni-Changer "M"	2X	15X	10X, 15X, 20X, 25X, 30X, 40X, 60X, 80X	1.5", 4"
59M-D3	Magni-Changer "M"	2X	10X, 15X	7X, 10X, 15X, 20X, 25X, 30X, 40X, 50X, 60X, 80X	1.5", 4"
59M-T1	Magni-Changer "M"	2/3X	10X	4.5X, 6X, 7X, 10X, 15X, 18X, 20X, 25X	4", 4.4"
<b>SPECIAL LONG WORKING DISTANCE COMBINATIONS</b>					
59FL-1	Special: Fixed "F"/2	—	10X	7.5X	8"
59FL-2	Special: Fixed "F"/2	—	15X	10X	8"
59JL-1	Magni-Changer "J" and 1/2X Objective	—	10X	3.5X, 7X, 15X	8"
59JL-2	Magni-Changer "J" and 1/2X Objective	—	15X	5X, 10X, 20X	8"
59KL-1	Magni-Changer "K" and 1/2X Objective	—	10X	5X, 7.5X, 10X	8"
59KL-2	Magni-Changer "K" and 1/2X Objective	—	15X	7X, 10X, 15X	8"
59ML-1	Magni-Changer "M" and 1/2X Objective	—	10X	3.5X, 5X, 7.5X, 10X, 12.5X	8"
59ML-2	Magni-Changer "M" and 1/2X Objective	—	15X	5X, 7.5X, 10X, 15X, 20X	8"

One No. 584 Extension Rod is supplied with Models 59FL, 59JL, 59KL, and 59ML. No. 1659 Cabinet for CYCLOPTIC Microscope Series 59F, 59J, 59K, and 59M is available at additional cost. See price insert. If 59S base-stage is not desired, substitute catalog number 55F, 55J, 55K, or 55M in place of 59F, 59J, 59K, or 59M in the above table. Series 55F, 55J, 55K, and 55M are readily adaptable to Standard Table Stand No. 52S, and large Universal Table Stand No. 53S. Cabinets are not available for CYCLOPTIC Series 55F, 55J, 55K, and 55M. See price insert sheet for 55 Series listings.

NOTE: No. 1157 20X Wide Field eyepieces are available for use with Series 55 and 59 and may be substituted at no increase in cost.



# CYCLOPTIC

## ALTERNATE PARTS

## and ACCESSORIES

### MEASURING AND COUNTING ACCESSORIES FOR 437, 1146, 1147 or 1157



1405A



1406A



1427

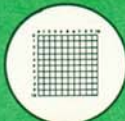

1408A

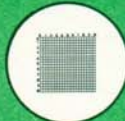

1409A



1410A

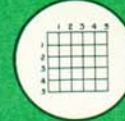

1421A



148



469

No additional charge is made for #148 or #469 when CYCLOPTIC Microscopes are ordered with counting or measuring disc.



424B

#### Catalog No.

#### Description

1405A	Micrometer Disc 5mm Scale divided into 50 units
1406A	Micrometer Disc 10mm Scale divided into 100 units
1407A	Micrometer Disc 10mm Scale divided into 200 units
1408A	Net Micrometer Disc 10mm square subdivided into 100 squares
1409A	Net Micrometer Disc 10mm square subdivided into 400 squares
1410A	Micrometer Disc 5mm Scale divided into 100 units
1421A	Net Micrometer Disc 5mm square subdivided into 25 squares
1427	Cross-Hair Disc
148	Micrometer Disc Mount for No. 1147 15X W.F. Eyepiece and No. 1157 20X W.F. Eyepiece.
469	Spanner Wrench for No. 1146 10X W.F. Eyepiece.
400	Stage Micrometer 2mm Scale divided into 200 .01mm units. Mounted on 25mm x 75mm slide. For calibration of eyepiece micrometer discs and fields of view.
1412	Special pre-calibrated disc which subtends a scale .200" long divided into 200 parts on the work. When used with 15X Wide Field eyepieces, either with "F" Series, or with Magni-Changer set at 20X, each small division will equal .001".
424B	Filar Micrometer Eyepiece 10X with English Scale
426B	Filar Micrometer Eyepiece 10X with Metric Scale

### WIDE FIELD EYEPieces



1146



1147



437

- 1146 10X W.F. AMERICOTE, Pair
- 1147 15X W.F. AMERICOTE, Pair
- 1156 2X BARLOW LENSES, Pair
- 1157 20X W.F. AMERICOTE, Pair
- \*437 10X W.F. Focusable Eyepiece.

\*Accepts standard reticles for 1146, 1147, and 1157 Eyepieces.



### PHOTOGRAPHIC TUBE ADAPTER

638

Single Photographic Tube Adapter (Does not include eyepiece.)



268



266



264



265

### APOCHROMATIC OBJECTIVES

- 268 Standard objective
- 266 1/2X Special long working distance objective for 53, 55, 59 only.
- 262 3/4X Special objective

### ACHROMATIC AUXILIARY LENS-ATTACHMENTS

- 267 2/3X Auxiliary Lens-Attachment
- 265 2X Auxiliary Lens-Attachment
- 264 2X Swing-out Lens-Attachment

### BLACK and WHITE STAGE PLATES 269

Stage plates Number 269 are intended for use with CYCLOPTIC Microscope Series 56, 58, and 59 . . . the set of two formica opaque plates—one white and the other black—are interchangeable with or may be specified instead of standard glass insert plates supplied with CYCLOPTIC Series 56, 58 and 59 at no additional cost.

269 Black and white stage plates . . . Set



### EYESHIELDS

149 For Eyepieces 1146 and 1147.

## BASES, STANDS, MECHANICAL STAGES, CABINETS



**30A**  
Phenolic-resin base-board  
7½" x 9½"



**30B**  
Phenolic-resin base-board  
12" x 17"

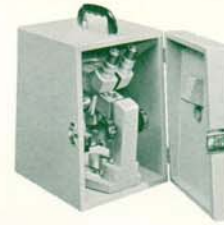

**1656** Cabinet for 56  
**1658** Cabinet for 58  
**1659** Cabinet for 59



**52S**  
Table Stand Model  
52S may be substituted for  
Universal Table Stand  
Model 53S or Base-Stage  
Model 59S supplied as  
standard with CYCLOPTIC  
Series 53 and 59  
respectively. See separate  
listings for Series 52.



**53S**  
Universal Table Microscope  
Stand for 53, 55, 59



**59S**  
Base-stage for 53, 55,  
59



**1556**  
Ungraduated Mechanical stage



**58S**  
Transilluminating substage base  
with mirror for 56, 58, 59



**59-852**  
Stage segment of  
59S



**59-851**  
Post receptacle with locking  
lever for 53, 55, 59



**584**  
3" Extension rod for 55, 59



**585**  
Lens protecting window and cell

## ILLUMINATORS

Cat. No.	Description
359	CYCLOSPOT Microscope Illuminator with prefocused two-lens condensing system, detachable universal arm, base-transformer, 6.5V 2.75 ampere clear glass lamp.
340A	Vertical Illuminator complete with lamphouse having multiple lens focusing system, 6.5V 2.75 ampere clear glass lamp, special bracket and hinge pin; vertical reflector; variable transformer.
341A	Lamphouse only, with multiple lens focusing system, 6.5V 2.75 ampere clear glass lamp, special bracket and hinge pin; variable transformer.
355	Replacement lamp 6.5V 2.75 ampere (G.E. No. 1497), for No. 359.
360	Replacement lamp 6.5V 2.75 ampere (G.E. No. 1493), for 340A, 341A.
640	Fluorescent Illuminator with aperture and thumb lock-screw for attachment to Cycloptic; complete with two day-light fluorescent tubes, two-button manual starting switch, cord and plug.

Cat. No.	Description
640A	Fluorescent Illuminator, same as 640 but with No. 642 three-link Jackknife Arm and heavy Base.
641	Fluorescent Illuminator same as 640 but with three-wire cord and No. 9413 Hubbell plug.
641A	Fluorescent Illuminator same as 640A but with three-wire cord and No. 9413 Hubbell plug.
642	Stand for Fluorescent Illuminators 640, 640A, 641, 641A consisting of three-link Jackknife Arm and heavy Base.



640



359



340A



SPENCER

## STEREOSCOPIC MICROSCOPES SERIES 23, 25, 26, 27, 28

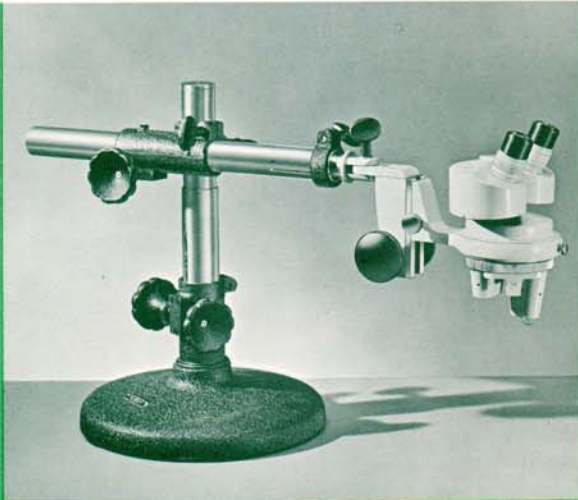

Series 23

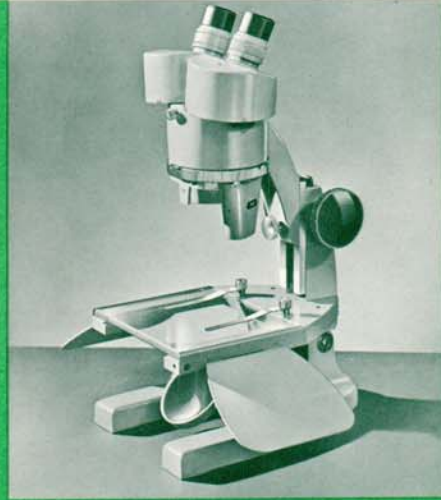

Series 25

### Outstanding Features

- *Conventional styling and design*
- *Inclined or vertical body*
- *Rigid and well balanced microscope stand*
- *Double extension dovetail slides*
- *Large field of view*
- *Dust-proof revolving nosepiece*
- *Interchangeable objectives*
- *Enhanced stereoscopic view*
- *Top quality optics*
- *Conventional working distance*
- *Wide range of magnifications*
- *Interpupillary and eye-refraction adjustments*
- *Erected and unreversed image*
- *Dove-gray Epoxy finish*
- *Broad selection of models*

## Top Quality Optics



World-famed AO SPENCER optical design assures clear, sharp and erect stereoscopic images . . . wide field eyepieces feature high eyepoints for eyeglass wearers . . . greater eye comfort for prolonged observations. 10X, 15X and 20X are available.

## Dust-Proof Revolving Nosepiece



Three nosepieces are available: triple, double revolving and single objective adapter. Objectives accurately revolve around a vertical axis . . . internal optical and mechanical parts are dust-proofed. Objectives in use always foremost . . . uninterrupted path for efficient illumination and effective manipulation of specimen.

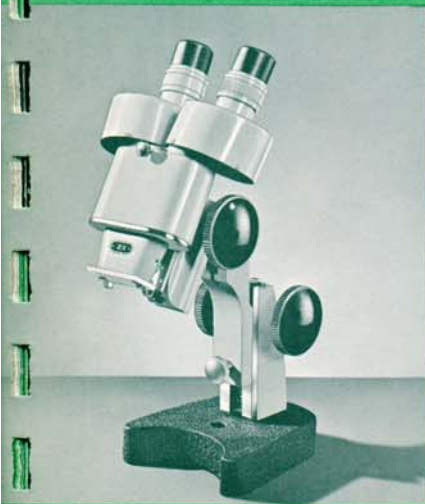

Series 27

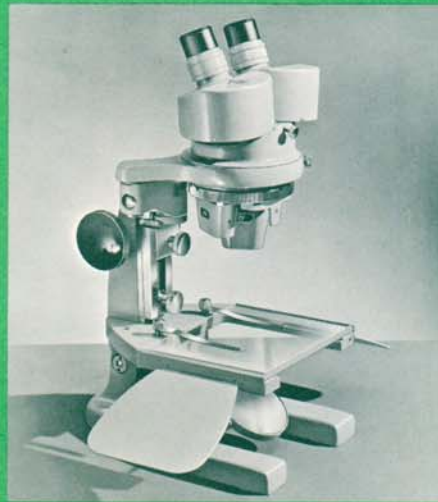

Series 28

## Rigid, Well-Balanced Microscope Stands

A wide selection of microscope stands is offered to meet your requirements. All are well-balanced, rigid . . . designed to withstand hard usage . . . insure lasting optical alignment. Adjustment controls are sensibly positioned for fatigue-free operation.



## Wide Range of Magnifications



Resultant magnification range of 7X to 160X is available. Intermediate magnifications are obtainable by various eyepiece-objective combinations. Objectives and paired eyepieces are instantly and easily interchanged.

## Inclined or Vertical Body

Both vertical and 22° inclined binocular bodies are available . . . adjustable for interpupillary and eye-refraction differences . . . securely house Porro prism erecting system. Reversed bodies are available upon special request at no extra charge.



SPENCER

## STEREOSCOPIC MICROSCOPE SERIES 23

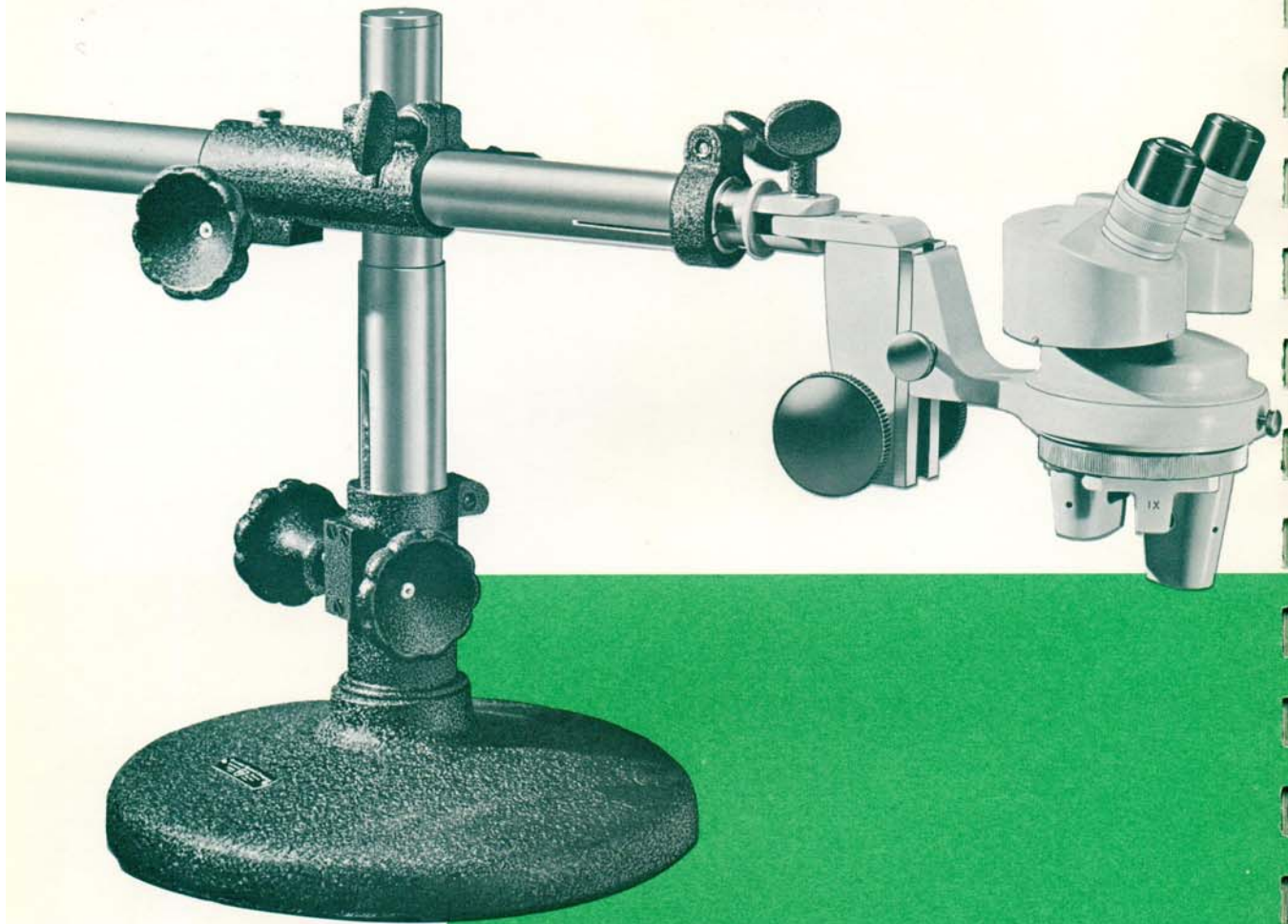

23LF

STEREOSCOPIC MICROSCOPE Series 23 are supplied with inclined binocular bodies . . . 360° rotatable optical head; triple, double revolving nosepiece or single objective adapter as selected; paired eyepieces and objectives as selected; rack and pinion focusing adjustment; heavy duty slideways; variable intermediate dovetail slide with locking thumb screw; large universal table stand.

A wide selection of STEREOSCOPIC MICROSCOPES SERIES 23 is available to satisfy your specific needs. Illustrated model 23LF . . . and tabulation of additional models on page 25 are presented to simplify your final selection.



# AO SPENCER STEREOSCOPIC MICROSCOPES ... SERIES 23

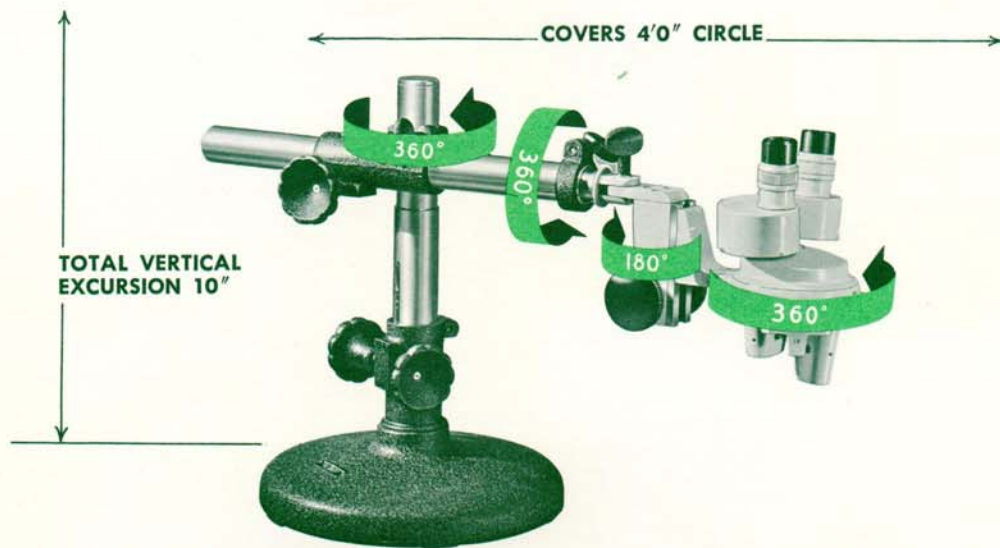

DISCONTINUED

Catalog Number	Binocular Body	Nosepiece	Paired Achromatic Objectives	Eyepieces	Magnification Range
23A	Vertical	Single	—	—	—
23E	Vertical	Double	—	—	—
23B	Vertical	Triple	—	—	—
23X	Vertical	Double	1.0X, 2.0X	10X W.F.	10X and 20X
23F	Vertical	Triple	1.0X, 2.0X, 3.0X	10X, 15X W.F.	10X to 45X
23G	Vertical	Triple	1.0X, 3.0X, 6.0X	10X, 15X W.F.	10X to 90X
23LA	Inclined	Single	—	—	—
23LE	Inclined	Double	—	—	—
23LB	Inclined	Triple	—	—	—
23LX	Inclined	Double	1.0X, 2.0X	10X W.F.	10X and 20X
23LF	Inclined	Triple	1.0X, 2.0X, 3.0X	10X, 15X W.F.	10X to 45X
23LG	Inclined	Triple	1.0X, 3.0X, 6.0X	10X, 15X W.F.	10X to 90X

Cabinet 1623 is available for binocular head and optics.

NOTE: No. 1157B 20X Wide Field eyepieces are available for use with Series 23 and may be substituted at no increase in cost.



SPENCER

## STEREOSCOPIC MICROSCOPE SERIES 25, 26

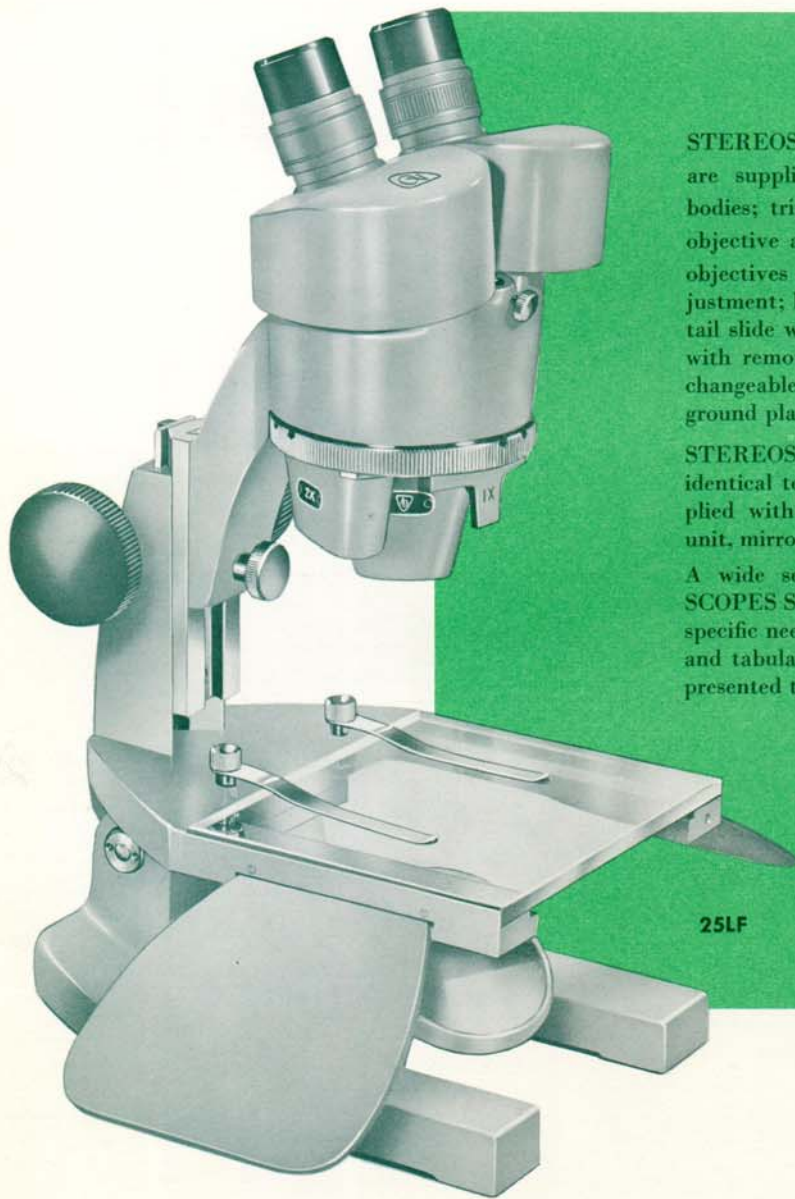

25LF

STEREOSCOPIC MICROSCOPE Series 25 and 26 are supplied with vertical or inclined binocular bodies; triple, double revolving nosepiece or single objective adapter as selected; paired eyepieces and objectives as selected; rack and pinion focusing adjustment; heavy duty slideways; intermediate dovetail slide with locking thumb screw; standard stage with removable glass stage, stage clips, and interchangeable black opaque and white translucent background plates.

STEREOSCOPIC MICROSCOPE Series 25 are identical to Series 26 except that Series 25 are supplied with Number 24 detachable horseshoe base unit, mirror, mirror-fork, hand rests.

A wide selection of STEREOSCOPIC MICROSCOPES Series 25 and 26 is available to satisfy your specific needs. Illustrated models 25LF and 26F . . . and tabulation of additional models on page 27 are presented to simplify your final selection.

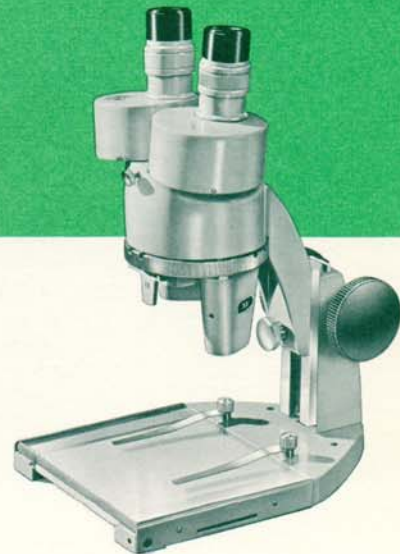

26F

# AO SPENCER STEREOSCOPIC MICROSCOPES

## . . . SERIES 25 and 26

	Catalog Number	Binocular Body	Nosepiece	Paired Achromatic Objectives	Eyepieces	Magnification Range
SERIES 25	25A	Vertical	Single	—	—	—
	25E	Vertical	Double	—	—	—
	25B	Vertical	Triple	—	—	—
	25X	Vertical	Double	1.0X, 2.0X	10X W.F.	10X and 20X
	25F	Vertical	Triple	1.0X, 2.0X, 3.0X	10X, 15X W.F.	10X to 45X
	25G	Vertical	Triple	1.0X, 3.0X, 6.0X	10X, 15X W.F.	10X to 90X
	25LA	Inclined	Single	—	—	—
	25LE	Inclined	Double	—	—	—
	25LB	Inclined	Triple	—	—	—
	25LX	Inclined	Double	1.0X, 2.0X	10X W.F.	10X and 20X
	25LF	Inclined	Triple	1.0X, 2.0X, 3.0X	10X, 15X W.F.	10X to 45X
	25LG	Inclined	Triple	1.0X, 3.0X, 6.0X	10X, 15X W.F.	10X to 90X
	SERIES 26	26A	Vertical	Single	—	—
26E		Vertical	Double	—	—	—
26B		Vertical	Triple	—	—	—
26X		Vertical	Double	1.0X, 2.0X	10X W.F.	10X and 20X
26F		Vertical	Triple	1.0X, 2.0X, 3.0X	10X, 15X W.F.	10X to 45X
26G		Vertical	Triple	1.0X, 3.0X, 6.0X	10X, 15X W.F.	10X to 90X
26LA		Inclined	Single	—	—	—
26LE		Inclined	Double	—	—	—
26LB		Inclined	Triple	—	—	—
26LX		Inclined	Double	1.0X, 2.0X	10X W.F.	10X and 20X
26LF		Inclined	Triple	1.0X, 2.0X, 3.0X	10X, 15X W.F.	10X to 45X
26LG		Inclined	Triple	1.0X, 3.0X, 6.0X	10X, 15X W.F.	10X to 90X

Cabinet 1625 is available for Stereoscopic Microscopes Series 25; Cabinet 1626 is available for Series 26.

NOTE: No. 1157B 20X Wide Field eyepieces are available for use with Series 25 and 26 and may be substituted at no increase in cost.



SPENCER

## STEREOSCOPIC MICROSCOPE... SERIES 27

STEREOSCOPIC MICROSCOPE Series 27 are supplied with vertical binocular body; paired eyepieces and objectives as selected; objective protecting glass; two rack and pinion focusing adjustments . . . variable intermediate dovetail slide with locking thumb screw; heavy duty slideways; 90° vertical inclination joint; heavy casted base.

A selection of STEREOSCOPIC MICROSCOPES Series 27 is available to satisfy your specific needs. Illustrated Model 27K . . . and tabulation of additional models below are presented to simplify your final selection.

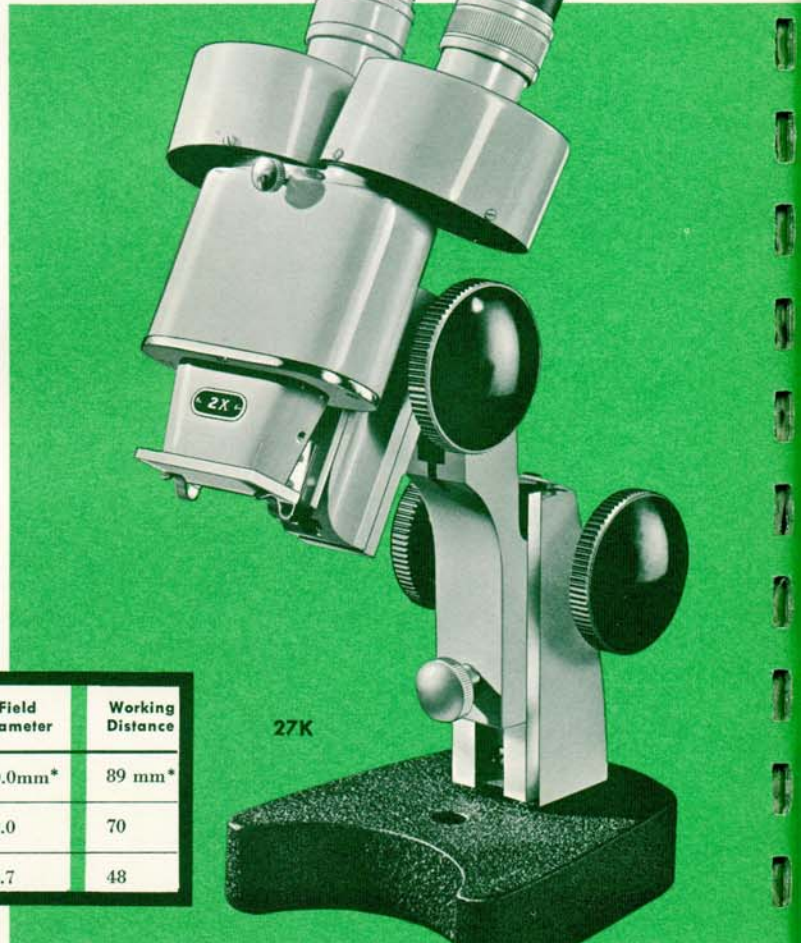
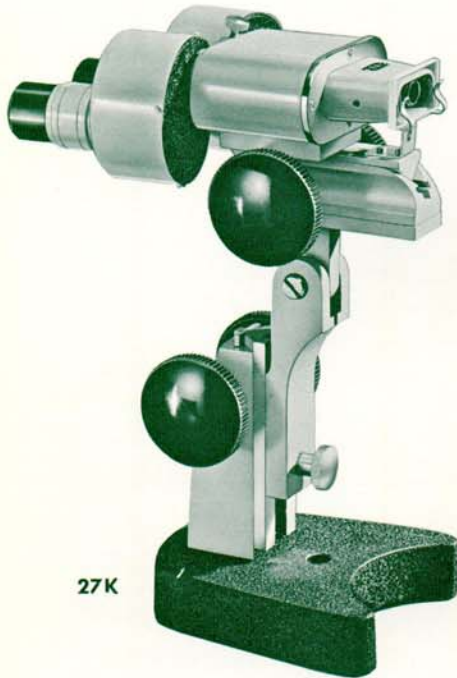

Catalog Number	Paired Objective	Paired W.F. Eyepieces	Total Magnification	Field Diameter	Working Distance
27J	1X	10X	10X	20.0mm*	89 mm*
27K	2	10X	20X	10.0	70
27L	3	10X	30X	6.7	48

Working distance is measured from object to front of protecting glass plate.

\*To convert to inches: divide by 25.4

Cabinet 1627 is available for Stereoscopic Microscope Series 27.



SPENCER

## STEREOSCOPIC MICROSCOPE . . . SERIES 28

STEREOSCOPIC MICROSCOPE Series 28L are supplied with inclined binocular bodies . . . 360° rotatable optical head . . . double swivel horizontal scanning arm; triple, double revolving nosepiece or single objective adapter as selected; paired eyepieces and objectives as selected; rack and pinion focusing adjustment; heavy duty slideways; double extension intermediate slides with locking thumb screws; standard stage with removable glass stage, stage clips, interchangeable black opaque and white translucent background plates; detachable horseshoe base unit, mirror, mirror-fork, hand rests . . . 8" x 12½" metal auxiliary stage.

Illustrated model 28LF . . . and tabulation of additional models on this page are presented to simplify your final selection.



28LF

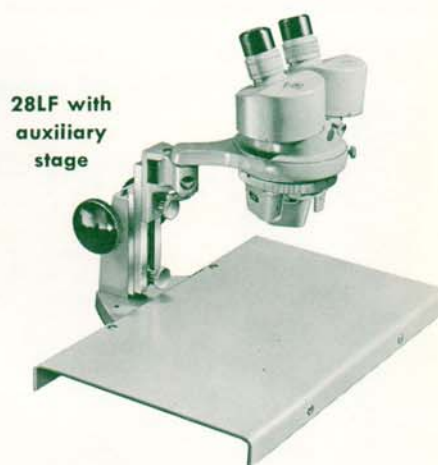

28LF with auxiliary stage

Catalog Number	Binocular Body	Nosepiece	Paired Achromatic Objectives	Eyepieces	Magnification Range
28LA	Inclined	Single	—	—	—
28LE	Inclined	Double	—	—	—
28LB	Inclined	Triple	—	—	—
28LX	Inclined	Double	1.0X, 2.0X	10X W.F.	10X and 20X
28LF	Inclined	Triple	1.0X, 2.0X, 3.0X	10X, 15X W.F.	10X to 45X
28LG	Inclined	Triple	1.0X, 3.0X, 6.0X	10X, 15X W.F.	10X to 90X

Cabinet 1628 is available for Stereoscopic Microscope Series 28.

NOTE: No. 1157B 20X Wide Field eyepieces are available for use with Series 28 and may be substituted at no increase in cost.



## PAIRED ACHROMATIC OBJECTIVES

Catalog Number	Description
271	1.0X for 27
272	2.0X for 27
273	3.0X for 27
294	0.7X for 23, 25, 26, 28
295	1.0X for 23, 25, 26, 28
296	2.0X for 23, 25, 26, 28
297	3.0X for 23, 25, 26, 28
298	4.0X for 23, 25, 26, 28
299	6.0X for 23, 25, 26, 28
300	8.0X for 23, 25, 26, 28

## EYESHIELDS



Catalog Number 149

For Eyepieces 1146B and 1147B. Not included with Series 23-28. Must be ordered separately.



## ACCESSORIES FOR STEREOSCOPIC MICROSCOPES

### EYEPIECES



1146B



1147B



426B

### MEASURING AND COUNTING ACCESSORIES FOR EYEPIECES 1146B, 1147B or 1157B

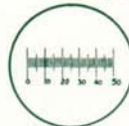

1405A

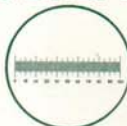

1406A



1427



1408A

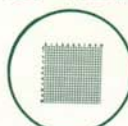

1409A



1410A



148



469

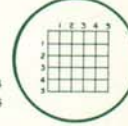

1421A

Catalog Number	Description
1405A	Micrometer Disc 5mm Scale divided into 50 units
1406A	Micrometer Disc 10mm Scale divided into 100 units
1407A	Micrometer Disc 10mm Scale divided into 200 units
1408A	Net Micrometer Disc 10mm square subdivided into 100 squares
1409A	Net Micrometer Disc 10mm square subdivided into 400 squares
1410A	Micrometer Disc 5mm Scale divided into 100 units
1421A	Net Micrometer Disc 5mm square subdivided into 25 squares
1427	Cross-Hair Disc
148	Micrometer Disc Mount for No. 1147B 15X W.F. Eyepieces and No. 1157B 20X W.F. Eyepieces.
469	Spanner Wrench for No. 1146B 10X W.F. Eyepiece
400	Stage Micrometer 2mm Scale divided into 200 .01mm units. Mounted on 25mm x 75mm slide. For calibration of eyepiece micrometer discs and fields of view. No additional charge is made for No. 148 or No. 469 when Stereoscopic Series 23-28 are ordered with counting or measuring disc.
424B	Filar Micrometer Eyepiece 10X with English Scale
426B	Filar Micrometer Eyepiece 10X with Metric Scale

Completely NEW four-optical-element wide field eyepieces offer superior image quality . . . wide field of view . . . full chromatic, curvature and distortion correction . . . comfortable eye relief even for eyeglass wearers.

Catalog Numbers 1146B, 1147B and 1157B 10X, 15X and 20X wide field eyepieces are specifically designed for use with stereoscopic microscopes described and illustrated on pages 20 through 31.

The new eyepieces are supplied with low reflection coating . . . and readily accept measuring and counting discs described.

Catalog Number	Eyepiece Description
1146B	10X W.F. AMERICOTE, Pair
1147B	15X W.F. AMERICOTE, Pair
1157B	20X W.F. AMERICOTE, Pair



## NOSEPIECES

Catalog Number	Description
442	Single Adapter for 23, 25, 26, 28
443	Double Revolving for 23, 25, 26, 28
446	Triple Revolving for 23, 25, 26, 28

## TABLE OF MAGNIFICATIONS AND FIELDS OF VIEW

Catalog Number	OBJECTIVES		EYEPIECES					
	Magnification	Working Distance	10X Wide Field Catalog No. 1146B		15X Wide Field Catalog No. 1147B		20X Wide Field Catalog No. 1157B	
			Magnif.	Field*	Magnif.	Field*	Magnif.	Field*
294	0.7X	95	7X	28.6	10.5X	24.0	15.0X	17.0
295	1.0	95	10.0	20.0	15.0	16.8	20.0	12.0
296	2.0	75	20.0	10.0	30.0	8.4	40.0	6.5
297	3.0	55	30.0	6.7	45.0	5.6	60.0	4.3
298	4.0	43	40.0	5.0	60.0	4.2	80.0	3.3
299	6.0	27	60.0	3.3	90.0	2.8	120.0	2.1
300	8.0	21	80.0	2.5	120.0	2.1	160.0	1.5

\*To convert millimeter values to inches: divide by 25.4

## CABINETS



1626

Catalog Number

Description

- 1623 Cabinet for 23 optical head only
- 1625 Cabinet for 25.
- 1626 Cabinet for 26.
- 1627 Cabinet for 27.
- 1628 Cabinet for 28.

## SERIES 23, 25, 26, 27 and 28

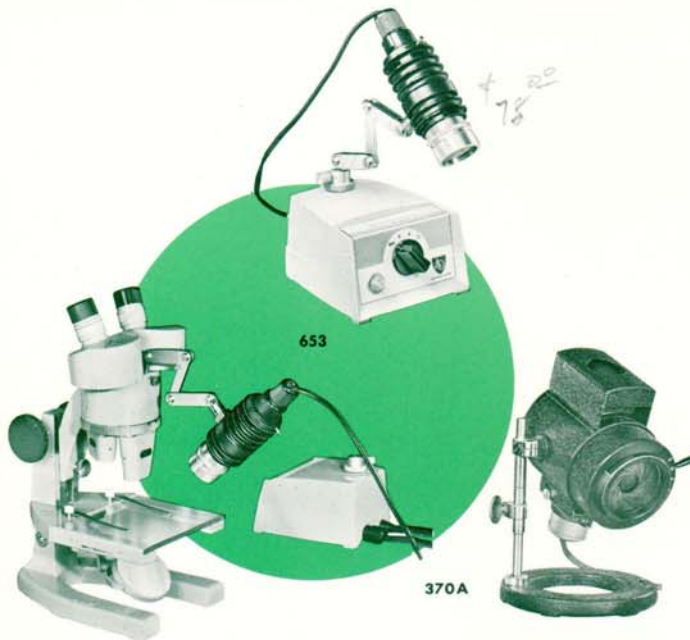

## ILLUMINATORS

Catalog Number

Description

- 653 Universal Microscope Illuminator, with three-link jackknife standard and with 6.5 volt, 2.75 ampere bulb, clear blue glass, ground glass filters and No. 651 Variable Transformer. UL and CSA Approved.
- 354 Iris diaphragm for 653.
- 360 Replacement lamp 6.5 volt, 2.75 ampere (G.E. 1493) for 653.
- 370A Adjustable Microscope Illuminator with iris diaphragm, blue and ground glass filters, 2 lens condensing system, adjustable ring stand, 100 watt, 120 volt bayonet base lamp and 5 foot cord with switch.
- 375 Replacement lamp 100 watt, 120 volt, bayonet base for 370A (G.E. 100G16½/29SC-120).
- 359 CYCLOSPOT (See page 8).

## BASES, STANDS MECHANICAL STAGES



24



1584A

Catalog Number

Description

- 235 Microscope stand and base for 23.
- 24 Horseshoe base unit with mirror for 25.
- 29A Phenolic-resin baseboard 7½" x 9½".
- 1584A Mechanical stage, ungraduated for 25, 28.
- 586 Objective protecting glass for 1X and 2X objectives, for 27.
- 587 Objective protecting glass for 3X objectives, for 27.

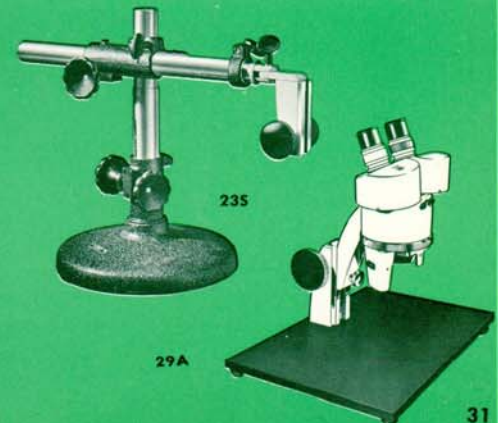

235

29A

31

The equipment supplied may not agree in all details with the descriptions or illustrations shown, as instruments are subject from time to time to modifications and improvement.

### **SALES AND SERVICE IN PRINCIPAL CITIES**

Sales Offices: Atlanta Boston Chicago Cincinnati Cleveland Dallas Detroit  
Houston Los Angeles Memphis Minneapolis New York Philadelphia  
Pittsburgh Sacramento San Francisco Seattle St. Louis Toronto Washington  
International Division: Southbridge, Mass.



**AMERICAN OPTICAL COMPANY**  
INSTRUMENT DIVISION • BUFFALO, N. Y. 14215



# PRICE LIST

## AO CYCLOPTIC . . . STEREOSCOPIC MICROSCOPES and Accessories

BROCHURE SB56 — EFFECTIVE JUNE 1, 1967

Page No.	Catalog Number	Unit Net Price Quantity 1 - 4	Unit Net Price Quantity 5 or more
10	638	\$115.00	\$103.50
	640	36.00	32.40
	653	78.00	70.20
	146	21.00	18.90
	147	21.00	18.90
	682G	494.00	444.60
13	53F-1	546.00	491.40
	53F-2	546.00	491.40
	53F-3	588.00	529.20
	53F-D1	578.00	520.20
	53F-D2	578.00	520.20
	53F-T1	578.00	520.20
	53J-1	672.00	604.80
	53J-2	672.00	604.80
	53J-D1	704.00	633.60
	53J-D2	704.00	633.60
	53J-T1	704.00	633.60
	53K-1	611.00	549.90
	53K-2	611.00	549.90
	53K-D1	643.00	578.70
	53K-D2	643.00	578.70
	53K-T1	643.00	578.70
	53M-1	698.00	628.20
	53M-2	698.00	628.20
	53M-3	740.00	666.00
	53M-D1	730.00	657.00
	53M-D2	730.00	657.00
53M-D3	772.00	694.80	
53M-T1	730.00	657.00	
53FL-1	559.00	503.10	
53FL-2	559.00	503.10	
53JL-1	685.00	616.50	
53JL-2	685.00	616.50	
53KL-1	624.00	561.60	
53KL-2	624.00	561.60	
53ML-1	711.00	639.90	
53ML-2	711.00	639.90	
15	56F-1	275.00	247.50
	56F-2	275.00	247.50
	56F-3	317.00	285.30
	56F-D1	307.00	276.30
	56F-D2	307.00	276.30
	56F-T1	307.00	276.30
	56J-1	401.00	360.90
	56J-2	401.00	360.90
	56J-D1	433.00	389.70
	56J-D2	433.00	389.70
	56J-D3	475.00	427.50
	56J-T1	433.00	389.70
	56K-1	340.00	306.00
	56K-2	340.00	306.00
	56K-D1	372.00	334.80
	56K-D2	372.00	334.80
	56K-T1	372.00	334.80
	56M-1	427.00	384.30
	56M-2	427.00	384.30
	56M-3	469.00	422.10

Page No.	Catalog Number	Unit Net Price Quantity 1 - 4	Unit Net Price Quantity 5 or more
15	56M-D1	\$459.00	\$413.10
	56M-D2	459.00	413.10
	56M-D3	501.00	450.90
	56M-T1	459.00	413.10
	1656	31.00	27.90
	17	58F-1	313.00
58F-2		313.00	281.70
58F-3		355.00	319.50
58F-D1		345.00	310.50
58F-D2		345.00	310.50
58F-T1		345.00	310.50
58J-1		439.00	395.10
58J-2		439.00	395.10
58J-D1		471.00	423.90
58J-D2		471.00	423.90
58J-D3		513.00	461.70
58J-T1		471.00	423.90
19	58K-1	378.00	340.20
	58K-2	378.00	340.20
	58K-D1	410.00	369.00
	58K-D2	410.00	369.00
	58K-T1	410.00	369.00
	58M-1	465.00	418.50
	58M-2	465.00	418.50
	58M-3	507.00	456.30
	58M-D1	497.00	447.30
	58M-D2	497.00	447.30
	58M-D3	539.00	485.10
	58M-T1	497.00	447.30
1658	31.00	27.90	
19	59F-1	321.00	288.90
	59F-2	321.00	288.90
	59F-3	363.00	326.70
	59F-D1	353.00	317.70
	59F-D2	353.00	317.70
	59F-T1	353.00	317.70
	59J-1	447.00	402.30
	59J-2	447.00	402.30
	59J-D1	479.00	431.10
	59J-D2	479.00	431.10
	59J-T1	479.00	431.10
	59K-1	386.00	347.40
	59K-2	386.00	347.40
	59K-D1	418.00	376.20
	59K-D2	418.00	376.20
	59K-T1	418.00	376.20
	59M-1	473.00	425.70
	59M-2	473.00	425.70
	59M-3	515.00	463.50
	59M-D1	505.00	454.50
	59M-D2	505.00	454.50
59M-D3	547.00	492.30	
59M-T1	505.00	454.50	

Page No.	Catalog Number	Unit Net Price Quantity 1 - 4	Unit Net Price Quantity 5 or more
19	59FL-1	\$340.00	\$306.00
	59FL-2	340.00	306.00
	59JL-1	466.00	419.40
	59JL-2	466.00	419.40
	59KL-1	405.00	364.50
	59KL-2	405.00	364.50
	59ML-1	492.00	442.80
	59ML-2	492.00	442.80
	584	6.00	5.40
	1659	31.00	27.90
	53S	260.00	234.00
	59S	35.00	31.50
	55F-1	286.00	257.40
	55F-2	286.00	257.40
	55F-3	328.00	295.20
	55F-T1	318.00	286.20
	55F-T2	318.00	286.20
	55F-T3	360.00	324.00
	55F-D1	318.00	286.20
	55F-D2	318.00	286.20
	55F-D3	360.00	324.00
55FL-1	299.00	269.10	
55FL-2	299.00	269.10	
55J-1	412.00	370.80	
55J-2	412.00	370.80	
55J-3	454.00	408.60	
55J-T1	444.00	399.60	
55J-T2	444.00	399.60	
55J-T3	486.00	437.40	
55J-D1	444.00	399.60	
55J-D2	444.00	399.60	
55J-D3	486.00	437.40	
55JL-1	425.00	382.50	
55JL-2	425.00	382.50	
55K-1	351.00	315.90	
55K-2	351.00	315.90	
55K-3	393.00	353.70	
55K-T1	383.00	344.70	
55K-T2	383.00	344.70	
55K-T3	425.00	382.50	
55K-D1	383.00	344.70	
55K-D2	383.00	344.70	
55K-D3	425.00	382.50	
55KL-1	364.00	327.60	
55KL-2	364.00	327.60	
55M-1	438.00	394.20	
55M-2	438.00	394.20	
55M-3	480.00	432.00	
55M-T1	470.00	423.00	
55M-T2	470.00	423.00	
55M-T3	512.00	460.80	
55M-D1	470.00	423.00	
55M-D2	470.00	423.00	
55M-D3	512.00	460.80	
55ML-1	451.00	405.90	
55ML-2	451.00	405.90	

SEE OTHER SIDE

Page No.	Catalog Number	Unit Net Price Quantity 1 - 4	Unit Net Price Quantity 5 or more
20	1405A	\$ 9.00	\$ 8.10
	1406A	10.00	9.00
	1407A	10.00	9.00
	1408A	16.50	14.85
	1409A	16.50	14.85
	1410A	9.00	8.10
	1421A	16.50	14.85
	1427	10.00	9.00
	148	1.00	.90
	469	.70	.63
	400	27.00	24.30
	1412	23.00	20.70
	437	38.00	34.20
	424B	128.00	115.20
	426B	128.00	115.20
	1146	42.00	37.80
	1147	42.00	37.80
	1156	85.00	76.50
	1157	42.00	37.80
	268	32.00	28.80
	266	45.00	40.50
	262	32.00	28.80
	267	32.00	28.80
	265	32.00	28.80
	264	55.00	49.50
	269	3.00	2.70
	638	115.00	103.50
	149	1.00	.90
21	30A	15.00	13.50
	30B	30.00	27.00
	1656	31.00	27.90
	1658	31.00	27.90
	1659	31.00	27.90
	52S	100.00	90.00
	53S	260.00	234.00
	59S	35.00	31.50
	1556	92.00	82.80
	58S	38.00	34.20
	59-852	10.00	9.00
	59-851	25.00	22.50
	584	6.00	5.40
	585	10.00	9.00
	359	36.00	32.40
	340A	148.00	133.20
	341A	96.00	86.40
	355	1.60	1.60
	360	1.02	1.02
	640	36.00	32.40
	640A	44.00	39.60

Page No.	Catalog Number	Unit Net Price Quantity 1 - 4	Unit Net Price Quantity 5 or more
21	641	\$ 49.00	\$ 44.10
	641A	57.00	51.30
	642	8.00	7.20
25	23A	discontinued	
	23E	discontinued	
	23B	discontinued	
	23X	discontinued	
	23F	discontinued	
	23G	discontinued	
	23LA	523.00	470.70
	23LE	546.00	491.40
	23LB	562.00	505.80
	23LX	690.00	621.00
	23LF	799.00	719.10
	23LG	808.00	727.20
	1623	32.00	28.80
27	25A	359.00	323.10
	25E	382.00	343.80
	25B	398.00	358.20
	25X	526.00	473.40
	25F	635.00	571.50
	25G	644.00	579.60
	25LA	412.00	370.80
	25LE	435.00	391.50
	25LB	451.00	405.90
	25LX	579.00	521.10
	25LF	688.00	619.20
	25LG	697.00	627.30
	26A	312.00	280.80
	26E	335.00	301.50
	26B	351.00	315.90
	26X	479.00	431.10
	26F	588.00	529.20
	26G	597.00	537.30
	26LA	365.00	328.50
	26LE	388.00	349.20
	26LB	404.00	363.60
	26LX	532.00	478.80
	26LF	641.00	576.90
	26LG	650.00	585.00
	1625	32.00	28.80
	1626	32.00	28.80
28	27J	437.00	393.30
	27K	437.00	393.30
	27L	437.00	393.30
	1627	32.00	28.80
29	28LA	523.00	470.70
	28LE	546.00	491.40
	28LB	562.00	405.80
	28LX	690.00	621.00
	28LF	799.00	719.10
	28LG	808.00	727.20
	1628	35.00	31.50

Page No.	Catalog Number	Unit Net Price Quantity 1 - 4	Unit Net Price Quantity 5 or more
30	271	\$ 51.00	\$ 45.90
	272	51.00	45.90
	273	51.00	45.90
	294	51.00	45.90
	295	51.00	45.90
	296	51.00	45.90
	297	51.00	45.90
	298	54.00	48.60
	299	60.00	54.00
	300	60.00	54.00
	149	1.00	.90
	1405A	9.00	8.10
	1406A	10.00	9.00
	1407A	10.00	9.00
	1408A	16.50	14.85
	1409A	16.50	14.85
	1410A	9.00	8.10
	1421A	16.50	14.85
	1427	10.00	9.00
	148	1.00	.90
	469	.70	.63
	400	27.00	24.30
	424B	128.00	115.20
	426B	128.00	115.20
	1146B	42.00	37.80
	1147B	42.00	37.80
	1157B	42.00	37.80
	442	7.00	6.30
	443	30.00	27.00
	446	46.00	41.40
31	294	51.00	45.90
	295	51.00	45.90
	296	51.00	45.90
	297	51.00	45.90
	298	54.00	48.60
	299	60.00	54.00
	300	60.00	54.00
	1623	32.00	28.80
	1625	32.00	28.80
	1626	32.00	28.80
	1627	32.00	28.80
	1628	35.00	31.50
	653	78.00	70.20
	354	12.50	11.25
	360	1.02	1.02
	370A	84.50	76.05
	375	2.00	2.00
	359	36.00	32.40
	23S	200.00	180.00
	24	47.00	42.30
	29A	discontinued	
	1584A	78.00	70.20
	586	4.00	3.60
	587	4.00	3.60

All prices, deliveries and terms of sale are subject to change without notice.

Applicable taxes are in addition to prices stated.

Orders are subject to final acceptance by the Sales Office at Buffalo with the understanding that prices and terms prevailing at time of delivery will apply. The equipment supplied may not agree in all details with the description or illustrations shown, as instruments are subject to modification and improvement.

NOTE: Cabinets are no longer included in price of Series 23, 25, 26, 27 and 28 Microscopes. They are available at additional cost as listed.



**AMERICAN OPTICAL COMPANY**  
INSTRUMENT DIVISION • BUFFALO, N. Y. 14215



# CYCLOPTIC

## MICROSCOPE...SERIES 52

CYCLOPTIC MICROSCOPE Series 52F, 52J, 52K and 52M are supplied with inclined, reversible binocular bodies; standard apochromatic objective or special long working distance 1/2X apochromatic objective as selected; eyepieces and auxiliary lens-attachments as selected; wide, durable, diagonally-cut rack and pinion focusing and positioning adjustments; large standard table stand.

CYCLOPTIC MICROSCOPE Series 52F has a fixed body magnification of 1.33X.

CYCLOPTIC MICROSCOPE Series 52J and 52K are equipped with Magni-

Changer "J" and "K" respectively, offering selection of three body magnifications; Series 52M is equipped with Magni-Changer "M", offering selection of five body magnifications. Resultant magnifications are indexed on the positioning dials.

Series 52 Standard Table Stand differs from 53 Series Universal Table Stand in that it provides manual adjustments of vertical pillar and horizontal arm instead of rack-and-pinion adjustments. A supporting ring is provided on the vertical post to permit a full 360° rotation of arm. See illustration for range of adjustments provided.

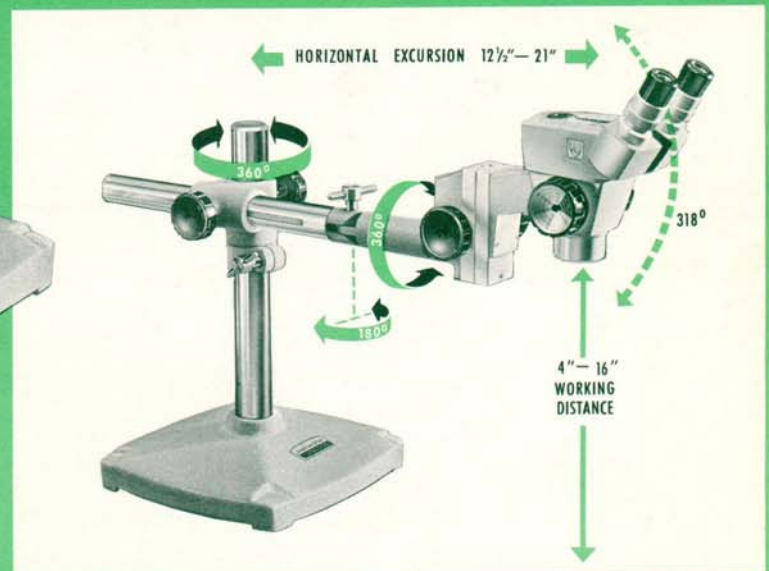
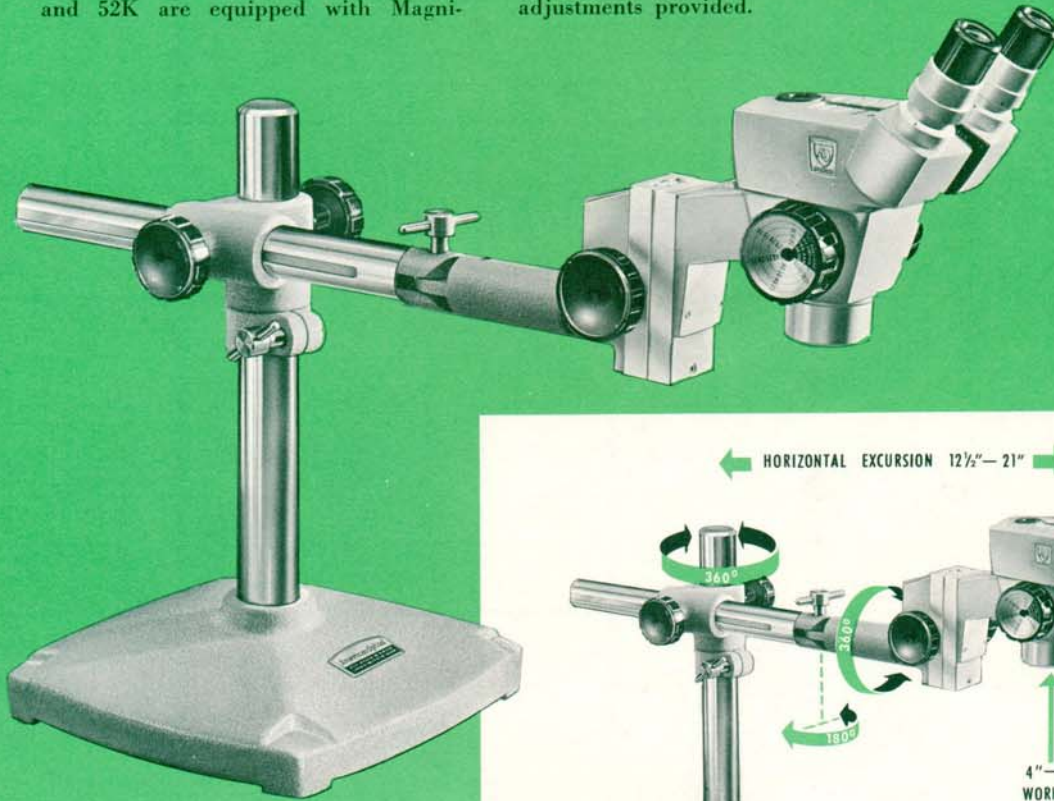





Illustrated model, 52M-1 and tabulation of additional models on opposite side of page are presented to simplify your final selection.

AMERICAN OPTICAL COMPANY

INSTRUMENT DIVISION

BUFFALO, N. Y. 14215

# AO SPENCER CYCLOPTIC SERIES 52F, 52J, 52K and 52M

	Catalog Number	Body Magnification	Auxiliary Lens-Attachment	Eyepieces Wide Field	Magnifications	Working Distance	Price	
<b>SERIES 52F</b> 	52F-1	Fixed "F"	—	10X	15X	4"	\$386.00	
	52F-2	Fixed "F"	—	15X	20X	4"	386.00	
	52F-3	Fixed "F"	—	10X, 15X	15X, 20X	4"	428.00	
	52F-D1	Fixed "F"	2X	10X	15X, 25X	1.5", 4"	418.00	
	52F-D2	Fixed "F"	2X	15X	20X, 40X	1.5", 4"	418.00	
	52F-T1	Fixed "F"	2/3X	10X	10X, 15X	4", 4.4"	418.00	
<b>SERIES 52J</b> 	52J-1	Magni-Changer "J"	—	10X	7X, 15X, 25X	4"	512.00	
	52J-2	Magni-Changer "J"	—	15X	10X, 20X, 40X	4"	512.00	
	52J-D1	Magni-Changer "J"	2X	10X	7X, 15X, 25X, 50X	1.5", 4"	544.00	
	52J-D2	Magni-Changer "J"	2X	15X	10X, 20X, 40X, 80X	1.5", 4"	544.00	
	52J-T1	Magni-Changer "J"	2/3X	10X	4.5X, 7X, 10X, 15X, 18X, 25X	4", 4.4"	544.00	
<b>SERIES 52K</b> 	52K-1	Magni-Changer "K"	—	10X	10X, 15X, 20X	4"	451.00	
	52K-2	Magni-Changer "K"	—	15X	15X, 20X, 30X	4"	451.00	
	52K-D1	Magni-Changer "K"	2X	10X	10X, 15X, 20X, 25X, 40X	1.5", 4"	483.00	
	52K-D2	Magni-Changer "K"	2X	15X	15X, 20X, 25X, 30X, 40X, 60X	1.5", 4"	483.00	
	52K-T1	Magni-Changer "K"	2/3X	10X	6X, 10X, 15X, 20X	4", 4.4"	483.00	
<b>SERIES 52M</b> 	52M-1	Magni-Changer "M"	—	10X	7X, 10X, 15X, 20X, 25X	4"	538.00	
	52M-2	Magni-Changer "M"	—	15X	10X, 15X, 20X, 30X, 40X	4"	538.00	
	52M-3	Magni-Changer "M"	—	10X, 15X	7X, 10X, 15X, 20X, 25X, 30X, 40X	4"	580.00	
	52M-D1	Magni-Changer "M"	2X	10X	7X, 10X, 15X, 20X, 25X, 40X, 50X	1.5", 4"	570.00	
	52M-D2	Magni-Changer "M"	2X	15X	10X, 15X, 20X, 25X, 30X, 40X, 60X, 80X	1.5", 4"	570.00	
	52M-D3	Magni-Changer "M"	2X	10X, 15X	7X, 10X, 15X, 20X, 25X, 30X, 40X, 50X, 60X, 80X	1.5", 4"	612.00	
	52M-T1	Magni-Changer "M"	2/3X	10X	4.5X, 6X, 7X, 10X, 15X, 18X, 20X, 25X	4", 4.4"	570.00	
	<b>SPECIAL LONG WORKING DISTANCE COMBINATIONS</b>	52FL-1	Special: Fixed "F"/2	—	10X	7.5X	8"	399.00
52FL-2		Special: Fixed "F"/2	—	15X	10X	8"	399.00	
52JL-1		Magni-Changer "J" and 1/2X Objective	—	10X	3.5X, 7X, 15X	8"	525.00	
52JL-2		Magni-Changer "J" and 1/2X Objective	—	15X	5X, 10X, 20X	8"	525.00	
52KL-1		Magni-Changer "K" and 1/2X Objective	—	10X	5X, 7.5X, 10X	8"	464.00	
52KL-2		Magni-Changer "K" and 1/2X Objective	—	15X	7X, 10X, 15X	8"	464.00	
52ML-1		Magni-Changer "M" and 1/2X Objective	—	10X	3.5X, 5X, 7.5X, 10X, 12.5X	8"	551.00	
52ML-2		Magni-Changer "M" and 1/2X Objective	—	15X	5X, 7.5X, 10X, 15X, 20X	8"	551.00	
52S		Standard Table Stand						100.00

Cabinets are not available for CYCLOPTIC Series 52F, 52J, 52K and 52M.

NOTE: No. 1157 20X Wide Field eyepieces are available for use with Series 52 and may be substituted at no increase in cost.