

ILLUMINATORS • CAMERAS AND RELATED ACCESSORIES  
MEASURING AND COUNTING ACCESSORIES • BODIES • NOSEPIECES • OBJECTIVES • STAGES • CONDENSERS  
PATHOSTAR • BACTISTAR • EYEPIECES  
MODEL 10 TRINOCULAR • MODEL 11 MONOCULAR  
MODEL 10 MONOCULAR • MODEL 10 BINOCULAR









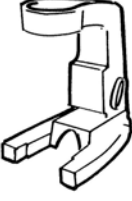

# PRICE LIST

## FOR SERIES 10, 11 MICROSTAR

December, 1967





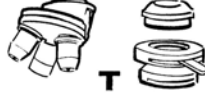



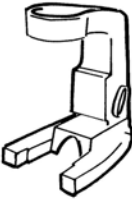

 **AO INSTRUMENT COMPANY**  
BUFFALO, NEW YORK 14216

## CODE FOR MODEL 10M MONOCULAR MICROSTAR

PREFIX	BASIC STAND	BODY	STAGE	HYPHEN	OBJECTIVES NOSEPIECE CONDENSER	EYEPIECE
 <b>U</b> #1034 On-Base Illuminator	 <b>10</b>	 <b>M</b> #1041 Monocular	 <b>S</b> Simple	-	 <b>H</b> #1076 10X Objective 1116 45X Objective 1079 100X Objective 1073 Triple Nosepiece 1088 N.A. 1.25 Cond. 1093 Condenser Mount 6140 Immersion Oil	 <b>W</b> #176 10X Wide Field
 <b>X</b> #1090 Auxiliary Swing-In Condenser			 <b>U</b> Ungraduated Mechanical		 <b>Q</b> #1075 4X Objective 1076 10X Objective 1116 45X Objective 1079 100X Objective 1074 Quad. Nosepiece 1088 N.A. 1.25 Cond. 1093 Condenser Mount 6140 Immersion Oil	
 <b>M</b> #1038 Mirror Assembly #406 Filter			 <b>F</b> Micro-Glide		 <b>T</b> #1075 4X Objective 1076 10X Objective 1116 45X Objective 1073 Triple Nosepiece 1089 N.A. 0.66 Cond. 1093 Condenser Mount	

#1090 Auxiliary Swing-In Condenser "X" is supplied with "XM10M" outfits combined with "Q".  
 #1610, 1611 Carrying Cases are NOT included with outfits.

## CODE FOR MODEL 10B BINOCULAR MICROSTAR

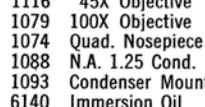
PREFIX	BASIC STAND	BODY	STAGE	HYPHEN	OBJECTIVES NOSEPIECE CONDENSER	EYEPIECE
 <b>N</b> #1037 On-Base Illuminator	 <b>10</b>	 <b>B</b> #1042 Binocular	 <b>U</b> Ungraduated Mechanical	-	 <b>H</b> #1076 10X Objective 1116 45X Objective 1079 100X Objective 1073 Triple Nosepiece 1088 N.A. 1.25 Cond. 1093 Condenser Mount 6140 Immersion Oil	 <b>W</b> #1176 10X Wide Field
 <b>X</b> #1090 Aux. Swing-in Condenser			 <b>G</b> Graduated Mechanical		 <b>Q</b> #1075 4X Objective 1076 10X Objective 1116 45X Objective 1079 100X Objective 1074 Quad. Nosepiece 1088 N.A. 1.25 Cond. 1093 Condenser Mount 6140 Immersion Oil	
 <b>L</b> #1036-In-Base Illuminator and Transformer #406 Filter			 <b>F</b> Micro-Glide		 <b>M</b> #1038 Mirror Assembly #406 Filter	

#1090 Auxiliary Swing-in Condenser "X" is supplied with "L" or "M" outfits combined with "Q".  
 #1610, 1611 Carrying Cases are NOT included with outfits.

**MODEL 10M MONOCULAR MICROSTARS**

CATALOG NO.	CONSUMER PRICE	
	1 - 4	5 or more
U10MU-QW	\$536.50	\$482.85
U10MU-QH	526.50	473.85
U10MU-HW	501.50	451.35
U10MU-HH	491.50	442.35
U10MU-TW	447.50	402.75
U10MU-TH	437.50	393.75
XM10MU-QW	547.00	492.30
XM10MU-QH	537.00	483.30
M10MU-HW	502.00	451.80
M10MU-HH	492.00	442.80
M10MU-TW	448.00	403.20
M10MU-TH	438.00	394.20
U10MF-QW	491.00	441.90
U10MF-QH	481.00	432.90
U10MF-HW	456.00	410.40
U10MF-HH	446.00	401.40
XM10MF-QW	501.50	451.35
XM10MF-QH	491.50	442.35
M10MF-HW	456.50	410.85
M10MF-HH	446.50	401.85
U10MF-TW	402.00	361.80
U10MF-TH	392.00	352.80
M10MF-TW	402.50	362.25
M10MF-TH	392.50	353.25
U10MS-HH	432.00	388.80
U10MS-TW	388.00	349.20
U10MS-TH	378.00	340.20
M10MS-HH	432.50	389.25
M10MS-TW	388.50	349.65
M10MS-TH	378.50	340.65

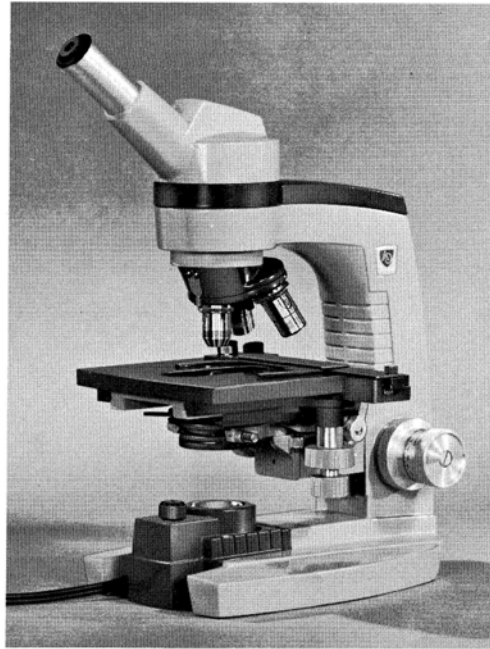

U10MU-HH

**MODEL 10B BINOCULAR MICROSTARS**

CATALOG NO.	CONSUMER PRICE	
	1 - 4	5 or more
XL10BU-QW	\$ 928.00	\$835.20
XL10BU-QH	908.00	817.20
L10BU-HW	883.00	794.70
L10BU-HH	863.00	776.70
XL10BG-QW	949.50	854.55
XL10BG-QH	929.50	836.55
L10BG-HW	904.50	814.05
L10BG-HH	884.50	796.05
XM10BU-QW	822.00	739.80
XM10BU-QH	802.00	721.80
M10BU-HW	777.00	699.30
M10BU-HH	757.00	681.30
XM10BG-QW	843.50	759.15
XM10BG-QH	823.50	741.15
M10BG-HW	798.50	718.65
M10BG-HH	778.50	700.65
N10BU-QW	817.00	735.30
N10BU-QH	797.00	717.30
N10BU-HW	782.00	703.80
N10BU-HH	762.00	685.80

CATALOG NO.	CONSUMER PRICE	
	1 - 4	5 or more
N10BG-QW	\$838.50	\$754.65
N10BG-QH	818.50	736.65
N10BG-HW	803.50	723.15
N10BG-HH	783.50	705.15
N10BF-HW	736.50	662.85
N10BS-HH	702.50	632.25

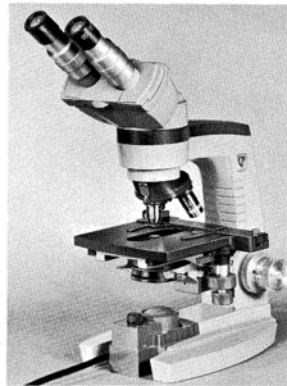



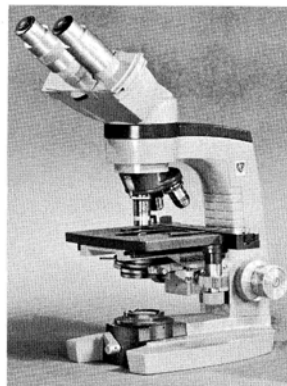







N10BU-HW

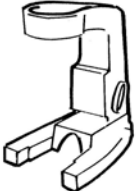

L10BU-HH







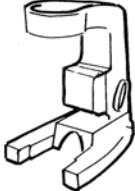

MEASURING AND COUNTING ACCESSORIES • BODIES • NOSEPIECES • OBJECTIVES • STAGES • CONDENSERS  
 PATHOSTAR • BACTISTAR • EYEPIECES  
 MODEL 10 TRINOCULAR • MODEL 11 MONOCULAR  
 MODEL 10 MONOCULAR • MODEL 10 BINOCULAR

## CODE FOR MODEL 10T TRINOCULAR MICROSTAR

PREFIX	BASIC STAND	BODY	STAGE	HYPHEN	OBJECTIVES NOSEPIECE CONDENSER	EYEPIECES
 <b>L</b> #1036 In-Base Illuminator & Transformer. #406 Filter   <b>X</b> #1090 Lux. Swing-in Condenser   <b>M</b> #1038 Mirror Assembly. #406 Filter	 <b>10</b>	 <b>T</b> #1043 Trinocular	 <b>U</b> Ungraduated Mechanical   <b>G</b> Graduated Mechanical	-	 <b>H</b> #1076 10X Objective 1116 45X Objective 1079 100X Objective 1073 Triple Nosepiece 1088 N.A. 1.25 Condenser 1093 Condenser Mount 6140 Immersion Oil   <b>Q</b> #1075 4X Objective 1076 10X Objective 1116 45X Objective 1079 100X Objective 1074 Quadruple Nosepiece 1088 N.A. 1.25 Condenser 1093 Condenser Mount 6140 Immersion Oil	 <b>W</b> #1176 10X Wide Field   <b>H</b> #1177 10X Huygenian

#1090 Aux. Swing-in Condenser "X" is supplied with "-Q" catalog outfits of model 10T.  
 #1610, 1611 Carrying Cases are NOT included with outfits.

## CODE FOR MODEL 11M MONOCULAR MICROSTAR

		STAGE & CONDENSER	HYPHEN	NOSEPIECE & OBJECTIVES
 <b>U</b> #1034 Illuminator	 <b>11</b>	 <b>PE</b> #1571 Plain Stage, Clips 227 In-Stage Cond. 223 Iris Diaphragm   <b>SA</b> #1571 Simple Stage, Clips 225 N.A. 1.25 Cond., Mt., Iris * or 229 N.A. 0.66 Cond., Mt., Iris   <b>FA</b> #1573 Micro-Glide, Clips 225 N.A. 1.25 Cond., Mt., Iris * or 229 N.A. 0.66 Cond., Mt., Iris   <b>UA</b> #1572 Ungrad. Mech. 225 N.A. 1.25 Cond., Mt., Iris * or 229 N.A. 0.66 Cond., Mt., Iris	-	 <b>D</b> #1072 Double 1076 10X Obj. 1116 45X   <b>T</b> #1073 Triple 1075 4X Obj. 1076 10X 1116 45X   <b>H</b> #1073 Triple 1076 10X Obj. 1116 45X 1079 100X 6140 Oil   <b>Q</b> #1074 Quad. 1075 4X Obj. 1076 10X 1116 45X 1079 100X 6140 Oil

#225 N.A. 1.25 Condenser is supplied with "H" and "Q" Objective outfits.  
 #229 N.A. 0.66 Condenser is supplied with "D" and "T" Objective outfits.  
 #224 Aux. Swing-in condenser "X" is supplied with XM11M outfits combined with "Q".  
 #1610, 1611 Carrying Cases are NOT included with catalog outfits.  
 Nosepiece reversed on "UA" outfits.

**MODEL 10T TRINOCULAR MICROSTARS**

CATALOG NO.	CONSUMER PRICE	
	1 - 4	5 or more
XL10TU-QW	\$ 971.00	\$873.90
XL10TU-QH	951.00	855.90
L10TU-HW	926.00	833.40
L10TU-HH	906.00	815.40
XL10TG-QW	992.50	893.25
XL10TG-QH	972.50	875.25
L10TG-HW	947.50	852.75
L10TG-HH	927.50	834.75
XM10TU-QW	865.00	778.50
XM10TU-QH	845.00	760.50
M10TU-HW	820.00	738.00
M10TU-HH	800.00	720.00
XM10TG-QW	886.50	797.85
XM10TG-QH	866.50	779.85
M10TG-HW	841.50	757.35
M10TG-HH	821.50	739.35



XM10TU-QW

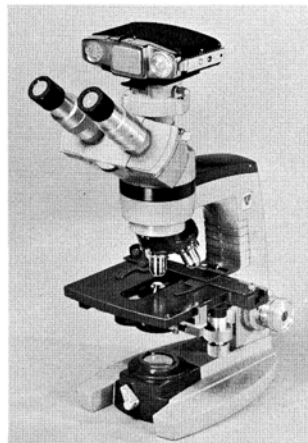

XL10TG-QW  
with 1053A Camera

**MODEL 11M MONOCULAR MICROSTARS**

CATALOG NO.	CONSUMER PRICE	
	1 - 4	5 or more
U11MPE-DH	\$294.50	\$265.05
U11MPE-TH	330.00	297.00
U11MPE-TW	340.00	306.00
M11MPE-DH	295.00	265.50
M11MPE-TH	330.50	297.45
M11MPE-TW	340.50	306.45
U11MSA-DH	321.00	288.90
U11MSA-TH	356.50	320.85
U11MSA-TW	366.50	329.85
M11MSA-DH	321.50	289.35
M11MSA-TH	357.00	321.30
M11MSA-TW	367.00	330.30
M11MSA-HH	411.00	369.90
M11MSA-HW	421.00	378.90
U11MFA-TH	370.50	333.45
U11MFA-TW	380.50	342.45
U11MFA-HH	424.50	382.05
U11MFA-HW	434.50	391.05
U11MFA-QH	459.50	413.55
U11MFA-QW	469.50	422.55
M11MFA-TH	371.00	333.90
M11MFA-TW	381.00	342.90
M11MFA-HH	425.00	382.50
M11MFA-HW	435.00	391.50
XM11MFA-QH	470.00	423.00
XM11MFA-QW	480.00	432.00



U11MPE-DH

CATALOG NO.	CONSUMER PRICE	
	1 - 4	5 or more
U11MUA-TH	\$416.00	\$374.40
U11MUA-TW	426.00	383.40
U11MUA-HH	470.00	423.00
U11MUA-HW	480.00	432.00
U11MUA-QH	505.00	454.50
U11MUA-QW	515.00	463.50
M11MUA-TH	416.50	374.85
M11MUA-TW	426.50	383.85
M11MUA-HH	470.50	423.45
M11MUA-HW	480.50	432.45
XM11MUA-QH	515.50	463.95
XM11MUA-QW	525.50	472.95

## PATHOSTAR SERIES 10

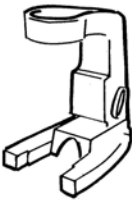
PREFIX	BASIC STAND	BODY	STAGE	HYPHEN	OBJECTIVES NOSEPIECE CONDENSER	EYEPIECES
<p><b>N</b> #1037 On-Base Illuminator</p> <p><b>L</b> #1036 In-Base Illuminator &amp; Transformer #406 Filter</p> <p><b>X</b> #1090 Auxiliary Swing-In Condenser</p> <p><b>M</b> #1038 Mirror Assembly #406 Filter</p>	 <b>10</b>	<p><b>B</b> #1042 Binocular</p> <p><b>T</b> #1043 Trinocular</p>	<p><b>U</b> Ungraduated Mechanical</p> <p><b>G</b> Graduated Mechanical</p>	-	<p><b>Q</b></p> <p>#1075 4X Objective #1076 10X Objective #1116 45X Objective #1079 100X Objective #1074 Quad. Nosepiece #1088 N.A. 1.25 Cond. #1093 Condenser Mount #6140 Immersion Oil</p>	<p><b>W</b></p> <p>#1176 10X Wide Field</p>



XL10TU-QW  
with 1050  
Viewing Screen

#1090 Auxiliary Swing-in Condenser "X" is supplied with "L" or "M" outfits combined with "Q".  
#1610, 1611 Carrying Cases are NOT included with outfits.

### TRINOCULAR 10T

### BINOCULAR 10B

CAT. NO	CONSUMER PRICE		CAT. NO	CONSUMER PRICE	
	1 to 4	5 or more		1 to 4	5 or more
XL10TU-QW	\$971.00	\$873.90	XL10BU-QW	\$928.00	\$835.20
XM10TU-QW	865.00	778.50	XM10BU-QW	822.00	739.80
XL10TG-QW	992.50	893.25	XL10BG-QW	949.50	854.55
XM10TG-QW	886.50	797.85	N10BU-QW	817.00	735.30

## BACTISTAR SERIES 10

### BACTERIA COUNT - BACTISTAR SERIES 10 MICROSTAR

CATALOG NUMBER	BODY	STAGE	INFINITY CORRECTED OBJECTIVES	EYEPIECES	CONDENSER	ILLUMINATOR	CONSUMER PRICE	
							1 to 4	5 or more
U10MU-HYZ	Monocular	Ungraduated Mechanical	10X, 45X, 100X oil immersion Triple Nosepiece	5X Huygenian Calibration Factor 300,000; 10X Huygenian Calibrated 600,000	Abbe N.A. 1.25	On-Base Illuminator	\$535.50	\$481.95
M10MU-HYZ	Same	Same	Same	Same	Same	Plano-Concave Mirror	536.00	482.40
N10BU-HYZ	Binocular	Same	Same	Same	Same	On-Base Illuminator	817.00	735.30
L10BU-HYZ	Same	Same	Same	Same	Same	In-Base Illuminator	918.00	826.20
M10BU-HYZ	Same	Same	Same	Same	Same	Plano-Concave Mirror	812.00	730.80

### MOLD COUNT BACTISTAR SERIES 10 MICROSTAR

U10MU-MC2	Monocular	Ungraduated Mechanical	10X, 20X Double Nosepiece	10X Huygenian Calibrated Field 1.382mm	N.A. 0.66	On-Base Illuminator	448.00	403.20
M10MU-MC2	Same	Same	Same	Same	Same	Plano-Concave Mirror	448.50	403.65
N10BU-MC3	Binocular	Same	10X, 20X, 45X, 100X Quadruple Nosepiece	Same	Abbe N.A. 1.25	On-Base Illuminator	861.50	775.35
L10BU-MC3	Same	Same	Same	Same	Same	In-Base Illuminator with Transformer	962.50	866.25
M10BU-MC3	Same	Same	Same	Same	Same	Plano-Concave Mirror	856.50	770.85

Microscope cabinets are not included; if desired see #1610, #1611.  
All essential optical surfaces of MICROSTAR Series 10 are AMERICOTE... to decrease internal reflection, increase light transmission and improve image contrast.

### TABLE OF RESULTANT MAGNIFICATION

OBJECTIVES					EYEPIECES					
Catalog Number	Initial Magnification	Focal Length in MM	Numerical Aperture N. A.	Working Distance in MM	1. FIELD OF VIEW and 2. EYE RELIEF IN MM					
					5X Huygenian Cat. #133	10X Huygenian Cat. #177	10X Wide Field Cat. #176	15X Wide Field Cat. #147	20X Wide Field Cat. #157	
					1075	4X	46.0	0.12	7.2	1.2
1076	10X	18.0	0.25	9.1	1.2	1.9 8.6	1.5 7.9	1.9 21.0	1.7 14.0	1.2 10.0
1077	20X	9.1	0.50	0.8	1.2	0.95 7.9	0.74 7.7	0.92 21.0	0.84 14.0	0.61 10.0
1078	45X	4.0	0.66	0.3*	1.2	0.42 7.7	0.33 7.6	0.41 21.0	0.37 14.0	0.27 10.0
1079	100X	1.8	1.25	0.1	1.2	0.19 7.0	0.15 7.5	0.18 21.0	0.17 14.0	0.12 10.0
1116	45X	4.0	0.66	0.7	1.2	0.42 7.7	0.33 7.6	0.41 21.0	0.37 14.0	0.27 10.0
1026**	50X	3.7	0.85	0.3	1.2	0.38 7.7	0.29 7.6	0.37 21.0	0.33 14.0	0.24 10.0
1027**	100X	1.8	1.25	0.1	1.2	0.19 7.0	0.15 7.5	0.18 21.0	0.17 14.0	0.12 10.0
1029	50X	3.7	0.85	0.3	1.2	0.38 7.7	0.29 7.6	0.37 21.0	0.33 14.0	0.24 10.0

NOTES: All working distances in air above a 0.18MM coverglass — from coverglass to mount.  
 Eye relief is distance from exit pupil (ideal position of eye) to top of eyepiece lens.  
 \* Working distance of 0.3 in air + 0.18 coverglass, equivalent to 0.63 in glass. Ample clearance for 0.4MM thick coverglass used with Hemacytometer.  
 \*\* With built-in iris diaphragm.

It is significant to note that when #176 10X Wide Field Eyepiece is used in combination with #1075 4X objective a 4.62mm field of view is obtained; and, #133 5X Huygenian Eyepiece when combined with the same objective subtends virtually the same field of view, 4.75mm. Since this relationship also holds true with other objectives, the old custom of specifying 5X and 10X

Huygenian Eyepieces is rapidly disappearing . . . customers are ordering 10X Wide Field instead of the two 5X and 10X Huygenian Eyepieces. It makes real sense; similar fields (at double the magnification) . . . more favorable eye relief (21.4 vs 9.5mm) . . . costs very little more (see price of #176 compared with price of #133 plus #177).

### ALTERNATE PARTS AND ACCESSORIES

FOR AO SERIES 10, 11

All essential optical surfaces of MICROSTAR Series 10, 11 as well as alternate parts and accessories are AMERICOTE . . . to decrease internal reflection, increase light transmission and improve image contrast.

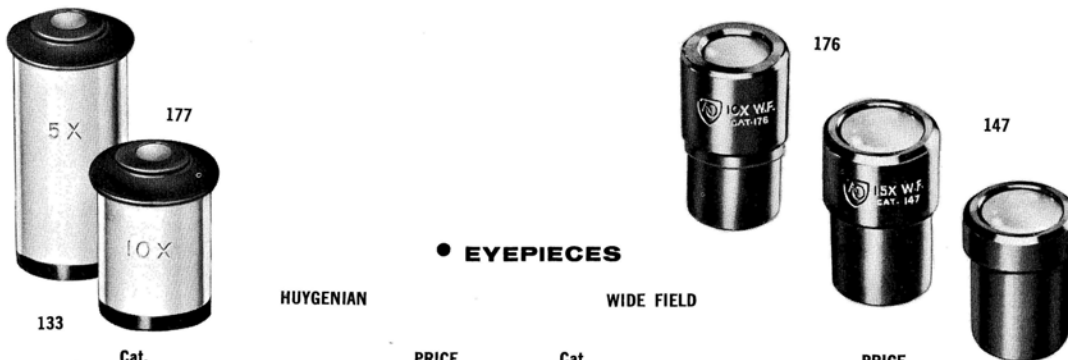

Cat. No.	Description	PRICE	
		1 to 4	5 or more
133	5X Americote, single	\$11.00	\$ 9.90
1133	5X Americote, paired	22.00	19.80
177	10X Americote, single	11.00	9.90
1177	10X Americote, pair	22.00	19.80

Cat. No.	Description	PRICE	
		1 to 4	5 or more
176	10X Americote, single	\$21.00	\$18.90
1176	10X Americote, pair	42.00	37.80
147	15X Americote, single	21.00	18.90
1147	15X Americote, pair	42.00	37.80
157	20X Americote, single	21.00	18.90
1157	20X Americote, pair	42.00	37.80
187	Eyeshield for 176	1.00	.90

## MEASURING AND COUNTING ACCESSORIES

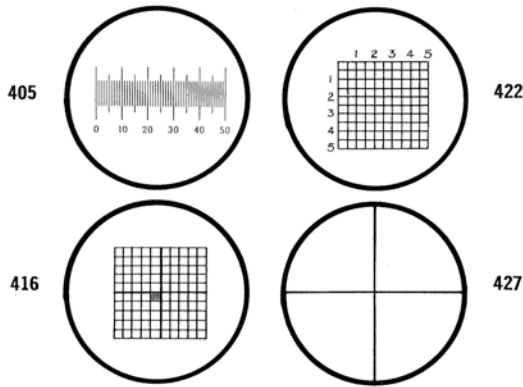

### MICROMETER DISCS (21MM DIAMETER) FOR HUYGENIAN EYEPIECES

CAT. NO.	DESCRIPTION	PRICE	
		1 to 4	5 or more
405	Micrometer Disc 5mm scale divided into 50 units	\$ 9.00	\$ 8.10
410	Micrometer Disc 5mm scale divided into 100 units	9.00	8.10
416	Whipple Net Micrometer Disc 7.5mm square subdivided into 100 squares. Center square further subdivided into 25 squares.	17.50	15.75
422	Net Micrometer Disc 5mm square subdivided into 100 squares	16.50	14.85
427	Cross-Hair Disc	10.00	9.00
413	Howard Mold Disc	17.50	15.75
417	Howard Mold Counting Chamber 75mm x 35mm; platform area 15mm x 20mm, depth 0.1mm; parallel lines 1.382mm apart traverse side of polished platform; includes two 28mm x 30mm cover glasses, 0.5mm and 1.0mm thick.	20.00	18.00

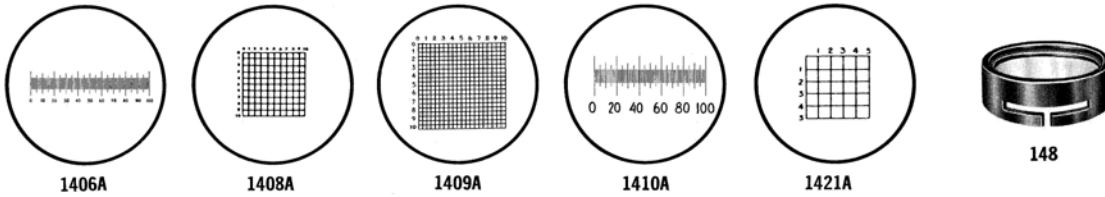

### MICROMETER DISCS (20MM DIAMETER) FOR WIDE FIELD EYEPIECES

CAT. NO.	DESCRIPTION	PRICE	
		1 to 4	5 or more
1405A	Micrometer Disc 5mm Scale divided into 50 units	\$ 9.00	\$ 8.10
1406A	Micrometer Disc 10mm Scale divided into 100 units	10.00	9.00
1407A	Micrometer Disc 10mm Scale divided into 200 units	10.00	9.00
1408A	Net Micrometer Disc 10mm square subdivided into 100 squares	16.50	14.85
1409A	Net Micrometer Disc 10mm square subdivided into 400 squares	16.50	14.85
1410A	Micrometer Disc 5mm Scale divided into 100 units	9.00	8.10
1421A	Net Micrometer Disc 5mm square subdivided into 25 squares	16.50	14.85
1427	Cross-Hair Disc	10.00	9.00
148	Micrometer Disc Mount for Wide Field Eyepieces Nos. 147 15X, 157 20X, and 176 10X	1.00	.90

### STAGE MICROMETER, MICROMETER EYEPIECE, FOCUSABLE EYEPIECE

CAT. NO.	DESCRIPTION	PRICE	
		1 to 4	5 or more
400	Stage Micrometer 2mm scale divided into 200 .01mm units. Mounted on 25mm x 75mm slide For calibration of eyepiece micrometer discs and fields of view.	\$ 27.00	\$ 24.30
426C	Filar Micrometer Eyepiece 10x with Metric Scale and Magnification Compensator.	151.00	135.90
426B	Filar Micrometer Eyepiece . . . same as above without Mag. Compensator but with plain eyepiece tube adapter. (See literature SB424 for further details)	128.00	115.20
437	10X W.F. Eyepiece with focusable eyelens. Accepts above 20mm diameter eyepiece discs.	38.00	34.20

### BODIES - Interchangeable for Series 10, 11

CAT. NO.	DESCRIPTION	PRICE	
		1 to 4	5 or more
1040	Vertical Monocular. Fixed Eyetube.	\$ 45.00	\$ 40.50
1041	Inclined Monocular "M"	27.00	24.30
1042	Binocular "B". Converging Eyetubes.	281.00	252.90
1043	Trinocular "T". Converging Eyetubes.	324.00	291.60
1046	Binocular. Parallel Eyetubes.	281.00	252.90
1047	Trinocular. Parallel Eyetubes.	324.00	291.60
1050	Viewing Screen for Series 10T	135.00	121.50

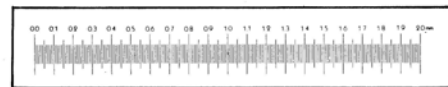

1041



1042

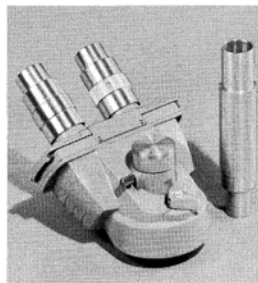

1043



1050

Transformer 1051H is recommended instead of #1051 supplied as standard with Models L10T, for use with #1050 viewing screen.



**NOSEPIECES**

CAT. NO.	DESCRIPTION	PRICE	
		1 to 4	5 or more
1072	Double Nosepiece	\$22.00	\$19.80
1073	Triple Nosepiece	27.00	24.30
1074	Quadruple Nosepiece	31.50	28.35
1105	Quintuple Nosepiece	43.00	38.70

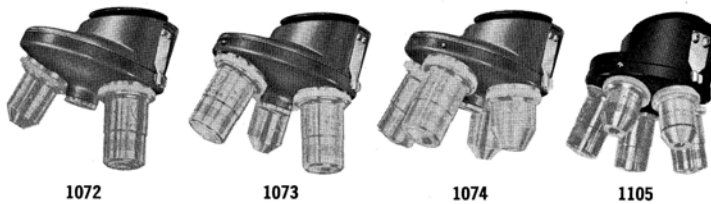

**ACHROMATIC OBJECTIVES - Infinity Corrected - For Series 10, 11**

CAT. NO.	DESCRIPTION	PRICE	
		1 to 4	5 or more
1075	4X (N.A. 0.12)	\$ 30.50	\$ 27.45
1076	10X (N.A. 0.25)	30.50	27.45
1077	20X (N.A. 0.50)	44.50	40.05
1078	45X (N.A. 0.66)	65.00	58.50
1079	100X (N.A. 1.25) Oil Immersion	84.50	76.05
*1116	45X (N.A. 0.66)	49.00	44.10
1026	50X (N.A. 0.85) with Iris Diaphragm. Oil Immersion.	130.00	117.00
1027	100X (N.A. 1.25) with Iris Diaphragm. Oil Immersion.	152.00	136.80
1029	50X (N.A. 0.85) No Iris Diaphragm. Oil Immersion.	86.00	77.40



\* Supplied as standard with all Model 10, 11 Microstars unless otherwise specified.

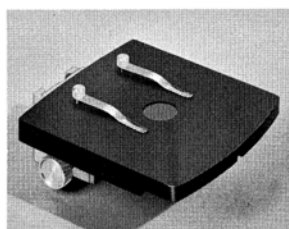

1060

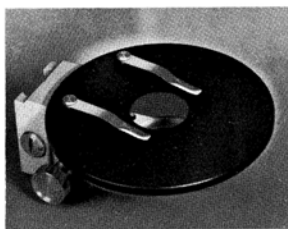

1061

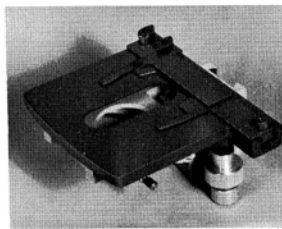

1062

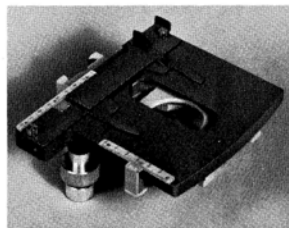

1065

**STAGES - For Series 10**

CAT. NO.	DESCRIPTION	PRICE	
		1 to 4	5 or more
1060	Simple Stage "S" with clips	\$ 65.00	\$ 58.50
1061	MICRO-GLIDE Stage "F" with clips	79.00	71.10
1062	Ungraduated Mechanical Stage "U". RH	124.50	112.05
1063	Ungraduated Mechanical Stage "U". LH	124.50	112.05
1064	Graduated Mechanical Stage "G". RH	146.00	131.40
1065	Graduated Mechanical Stage "G". LH	146.00	131.40

**CONDENSERS AND CONDENSER MOUNTS - For Series 10**

CAT. NO.	DESCRIPTION	PRICE	
		1 to 4	5 or more
1088	N.A. 1.25 Abbe Condenser	\$ 22.00	\$ 19.80
1089	N.A. 0.66 Abbe Condenser	22.00	19.80
1090	Auxiliary Swing-In Condenser "X"	10.00	9.00
1093	Condenser Mount. Fixed, Fork Type	13.00	11.70
1095	Condenser Mount. Centerable, Fork Type	41.50	37.35
214F	Dark Field Condenser. Centerable, Fork Type	91.00	81.90
218F	Dark Field Condenser. Centerable, Fork Type. Built-in 6.5 V 1.7 amp. illuminator. Without transformer.	141.00	126.90
1051	Variable Transformer, 110V for 218F	24.00	21.60
1051H	Variable Transformer 4.5-8V for 1050, L10T	36.00	32.40
406	Clear blue filter; 31mm diameter	1.50	1.35



1088



1089



1090



1093



1095

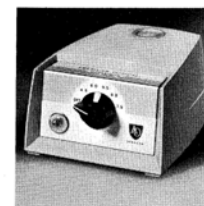

1051

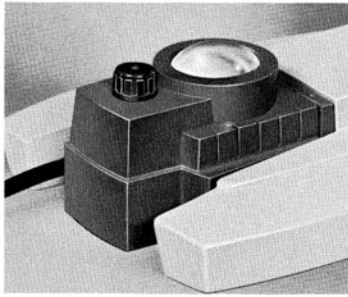

1034

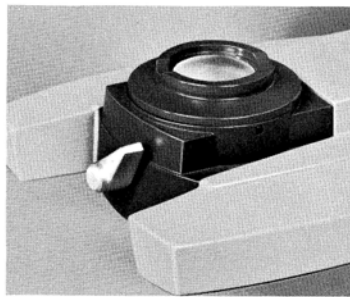

1036

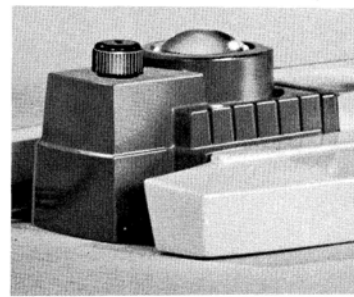

1037

**ILLUMINATORS AND MIRROR ASSEMBLY**

CAT. NO.	DESCRIPTION	PRICE	
		1 to 4	5 or more
1034	On-Base Illuminator "U" for Monocular MICROSTARS 10M, 11M	\$ 11.00	\$ 9.90
1036	In-Base Illuminator "L" complete with 1051 Transformer	117.50	105.75
1037	On-Base Illuminator "N" for Binocular MICROSTARS 10B	16.50	14.85
1038	Plano Concave Mirror Assembly "M"	11.50	10.35
370A	Adjustable Microscope Illuminator with iris diaphragm, blue and ground glass filters, 2 lens system, with adjustable ring stand, 100 watt, 120 volt bayonet base lamp, and 5' cord with switch.	84.50	76.05
600	Ortho-Illuminator complete with three-point positioning device for microscope base; turret-mounted intensity and color filters; pinhole eyepiece; one 100 watt, 115 volt lamp; two-way switch, cord and plug.	205.00	184.50
735C	Microscope Illuminator with multiple filter holder, iris diaphragm, blue and ground glass filters, rack-and-pinion focus condensing system, screw type tilting adjustment in base, integral heat absorbing glass, 100 watt, 120 volt lamp and 8' cord with switch. UL and CSA approved.	119.00	107.10
611	Replacement lamp 15W115V, GE15S/102 for 1034, 1037	.35	
1033	Replacement lamp 2.75A 6.5V GE 1460 for 1036	2.23	

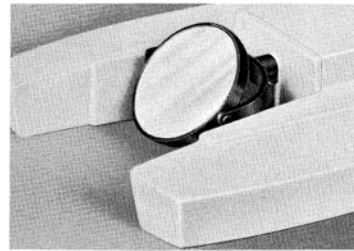

1038



370A

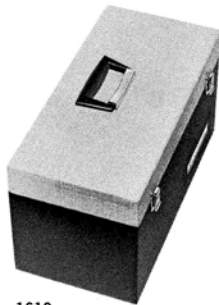

1610

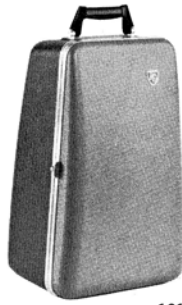

1611



735C

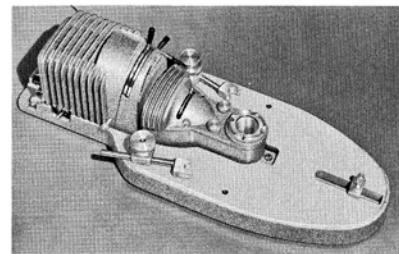

600

**CABINETS**

CAT. NO.	DESCRIPTION	PRICE	
		1 to 4	5 or more
1610	Cabinet for 10, 11	\$30.50	\$27.45
1611	Deluxe Cabinet for 10	40.00	36.00

**POLARIZING ACCESSORIES for Models L10**

CAT. NO.	DESCRIPTION	PRICE	
		1 to 4	5 or more
1113	Polarizer Unit, consists of swing-in polarizing disc, rotatable, for #1036	\$22.00	\$19.80
1114	Analyzer Turret Unit; has three apertures, one contains Polaroid disc.	52.00	46.80
1114B	Consists of 1113, 1114	74.00	66.60

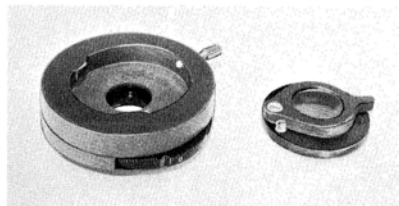

1114

1113

**CAMERAS AND RELATED ACCESSORIES**  
For Series 10T

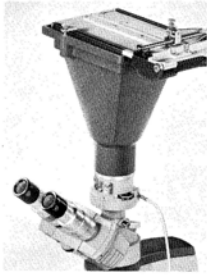

1055A



1052

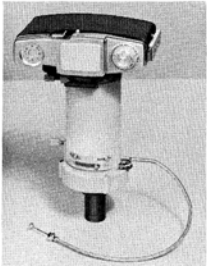

1053A Camera illustrated with adapter in position for factor of 5X photomicrography.

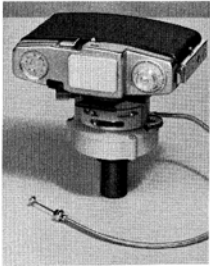

1053A Camera illustrated with 5X adapter removed for factor of 2.8X photomicrography.

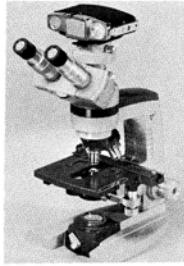

XL10TG-QW with 1053A

CAT. NO.	DESCRIPTION	PRICE	
		1 to 4	5 or more
1052A	3 1/4" x 4 1/4" film pack Polaroid Camera consisting of #1052 Camera Back and 7.5X Adapter; #1057 Shutter, Cable and Lens Assembly; #1054 Field of View Eyepiece. Magnification factor 7.5X.	\$294.00	\$264.60
1052	3 1/4" x 4 1/4" film pack Polaroid Camera Back. Magnification factor 7.5X.	150.00	135.00
1053A	35mm Camera consisting of #1053 Camera Back; #1057 Shutter, Cable and Lens Assembly; #1054 Field of View Eyepiece. Magnification factors 2.8 and 5X.	219.00	197.10
1053	35mm Camera Back.	75.00	67.50
1055A	4" x 5" Camera Back Adapter consisting of #1055 Camera Back Adapter; #1057 Shutter, Cable and Lens Assembly; #1054 Field of View Eyepiece. Magnification factor 10X. Accepts 4" x 5" Cut Film Holders, and Polaroid #500 Camera Back for 4" x 5" Polaroid Film Pack (#500 not supplied by AO).	234.00	210.60
1055	4" x 5" Camera Back Adapter.	90.00	81.00
1054	Field of View Eyepiece.	44.00	39.60
1057	Shutter, Cable and Lens Assembly. Magnification factors 2.8X and 5X.	100.00	90.00

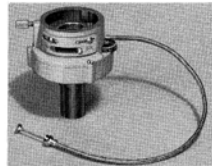

1057



1054

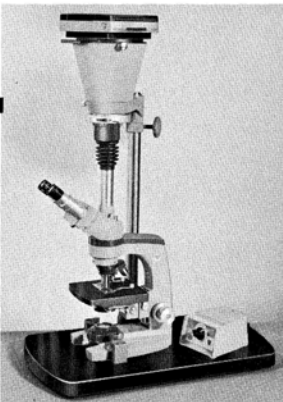

1070G

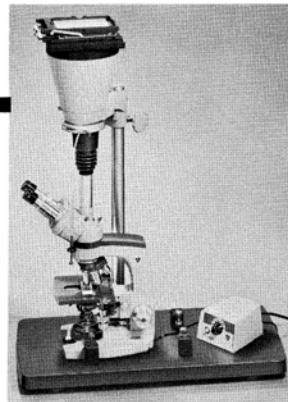

1070F

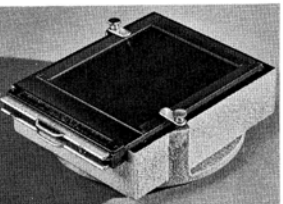

687



690

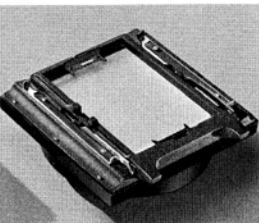

688



1058



1154

CAT. NO.	DESCRIPTION	PRICE	
		1 to 4	5 or more
1070B	4" x 5" Camera consisting of base; post; arm; 1070 shutter, cable, adapter assembly; 1059 Photographic eyepiece; 1154 Field of view eyepiece; 656 light-tight connector; 657 cone adapter; 687 4" x 5" camera back; ground glass screen; two 675 double cut film holders for 4" x 5" cut film.	\$378.00	\$340.20
1070C	35mm Camera consisting of base; post; arm; 1070 shutter, cable, adapter assembly; 1058 photog. eyepiece; 1154 Field of view eyepiece; 656 light-tight connector; 1069 camera back.	401.00	360.90
1070D	4" x 5" and 35mm Cameras consisting of base; post; arm; 1070 shutter, cable, adapter assembly; 1058, 1059 photog. eyepieces; 1154 Field of view eyepiece; 656 light-tight connector; 657 cone adapter; 687 4" x 5" camera back; ground glass screen; two 675 double cut film holders for 4" x 5" cut film; 1069 camera back.	490.00	441.00
1070F	4" x 5" Graflok Camera. Same as 1070B but with 688 4" x 5" Graflok camera back instead of 687 4" x 5" camera back.	396.00	356.40
1070G	3 1/4" x 4 1/4" Polaroid Camera consisting of base; post; arm; 1070 shutter, cable, adapter assembly; 1059 photog. eyepiece; 1154 Field of view eyepiece; 656 light-tight connector; 657 cone adapter; 690 Polaroid camera back.	467.00	420.30
1058	35mm Photographic Eyepiece for use with 1070, 1069	22.00	19.80
1059	4" x 5" and 3 1/4" x 4 1/4" Photographic Eyepiece for use with 1070, 687, 688, 689, 690	22.00	19.80
1069	35mm Camera Back for 10T, 1070	90.00	81.00
687	4" x 5" Camera Back for 10T, 1070	39.00	35.10
688	Graflok Camera Back for 10T, 1070	57.00	51.30
690	3 1/4" x 4 1/4" film pack Polaroid Camera Back	140.00	126.00
1154	Field of view eyepiece for 10, 1070	44.00	39.60

The equipment supplied may not agree in all details with the descriptions or illustrations shown, as instruments are subject to modification and improvement.

® REGISTERED TRADE MARK AMERICAN OPTICAL CORPORATION



**AO INSTRUMENT COMPANY**  
**BUFFALO, NEW YORK 14215**