

Reichert

**Cycloptic
Stereoscopic
Microscopes**



CYCLOPTIC[®] MICROSCOPES Outstanding Features:

1. Reversible and inclined body
2. Long working distance
3. Large field of view
4. Wide range of magnifications
5. Erected and unreversed stereoscopic image
6. Top quality optics . . . low reflection coated
7. Adjustable for interpupillary and eye-refraction differences
8. Rigid, well balanced stands



©Reichert Scientific Instruments 1985

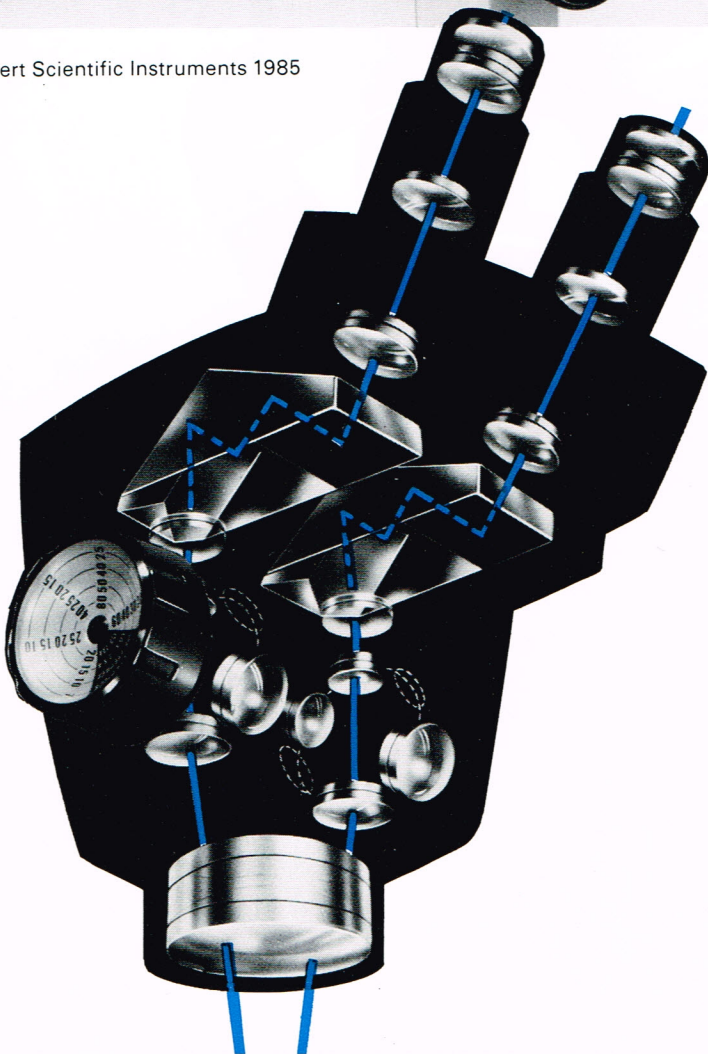

HIGH QUALITY OPTICS

Body Magnifications

Two types of models are available for all Series CYCLOPTIC Microscopes (52, 53, 55, 56, 58, 59): "F," with fixed body magnification of 1.33X and "M" having a convenient MagniChanger which permits dial-in selection of magnifications by simple rotation to indicated values.

"M" contains 16 achromatically corrected optical elements . . . offers five different magnifications for each eyepiece-objective combination.

Intermediate magnifications can be obtained by alternate eyepieces, substitution and/or addition of basic objectives or auxiliary lens attachments.

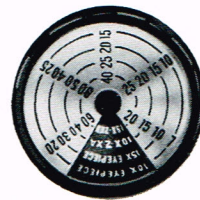

Wide Field Eyepieces

Four-optical-element eyepieces offer superior image quality, wide field of view, full chromatic, curvature and distortion correction as well as comfortable eye relief for eyeglass wearers. 10X, 15X, 20X are available. All are supplied with low reflection coating, AMERICOTE. All accommodate measuring and counting accessory reticles. (See Accessory section).

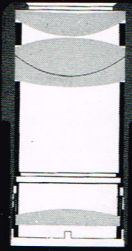

Adjustable Tension

Tension on focusing control knobs is conveniently adjustable to suit individual touch or to compensate for normal wear over period of years. To increase tension, hold one knob firmly and turn opposite knob clockwise... counterclockwise turn loosens tension.

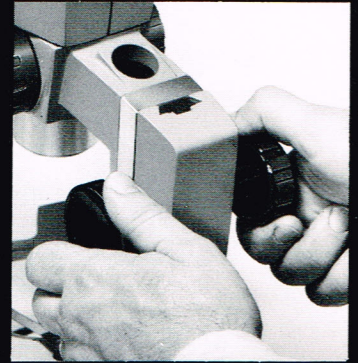

Apochromatic Objectives

Five special wide angle objectives (three-lens and two-lens) apochromats are well corrected for chromatic and spherical aberrations and present a crisp, true enhanced stereoscopic image over the full field of view.

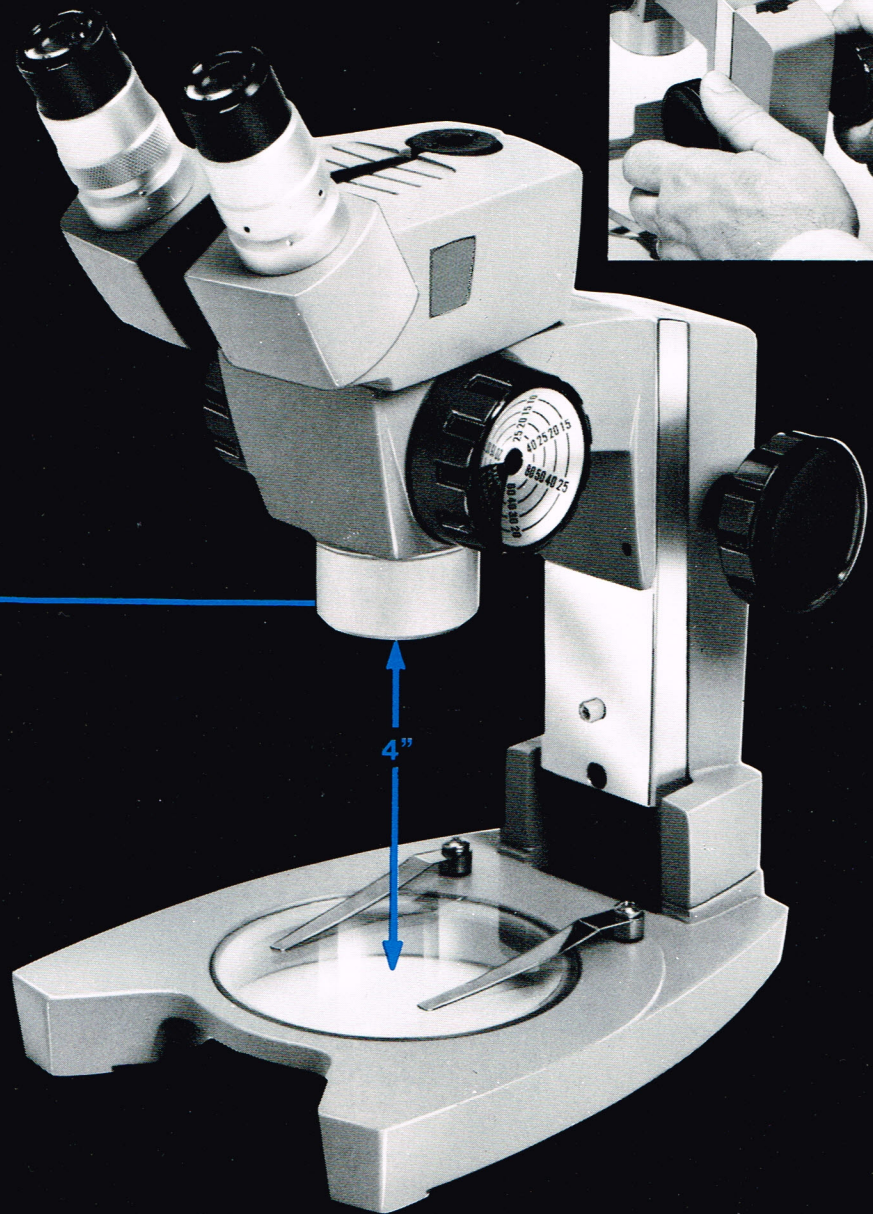
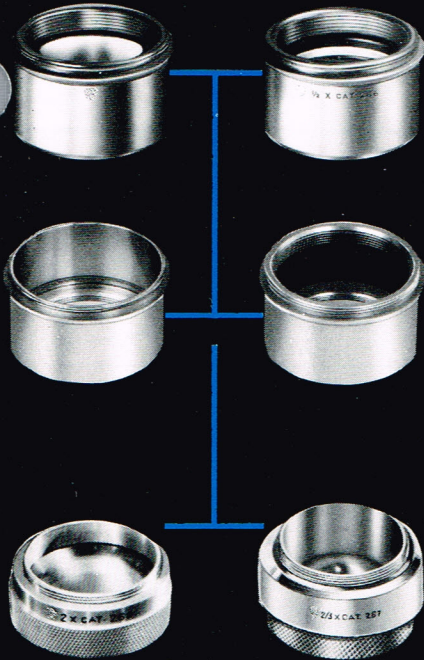

Achromatic Auxiliary Lens Attachments



Two achromatically corrected auxiliary lens attachments are available which readily attach to the basic objective to extend the useful range of magnifications.

Exceptionally Long Working Distances

Standard CYCLOPTIC Microscopes provide constant long working distance of 4" between specimen and objective. Working distance of 8" is obtained with use of 1/2X objective on Series 53, 55 and 59. Special 1/3X objective will provide 12.5" and 1/5X objective will provide 20" working distance with Series 53 and 55. These unusually long working areas provide for easy manipulation of gross specimens and are ideally adaptable to manufacturing phases of assembly and quality control.

See chart showing field sizes related to working distances.

TABLE OF RESULTANT MAGNIFICATIONS, FIELD OF VIEW AND WORKING DISTANCES

EYEPIECES	OBJECTIVE/ AUXILIARY LENS ATTACHMENT	RESULTANT MAGNIFICATION		FIELD OF VIEW*	WORKING DISTANCE*
		"F"	"M"		
10X #1146 (Eye Relief 19.0 mm) 	Standard #268	—	7X	1.20"	4.0"
		—	10X	0.90"	
		15X	15X	0.60"	
		—	20X	0.40"	
		—	25X	0.30"	
		—	—	—	
	2X #265	—	15X	0.60"	1.5"
		—	20X	0.45"	
		25X	25X	0.30"	
		—	40X	0.20"	
		—	50X	0.15"	
	2/3X #267	—	4.5X	1.80"	4.4"
		—	6X	1.35"	
		10X	10X	0.90"	
		—	15X	0.60"	
		—	18X	0.45"	
	1/2X** #266	—	3.5X	2.40"	8.0"
		—	5X	1.80"	
7X		7X	1.20"		
—		10X	0.80"		
—		15X	0.60"		
1/3X** #K1932	—	2.3X	3.60"	12.5"	
	—	3.3X	2.70"		
	5X	5.0X	1.80"		
	—	6.7X	1.20"		
	—	8.3X	0.90"		
1/5X** #K1987	—	1.4X	6.00"	20"	
	—	2X	4.50"		
	3X	3X	3.00"		
	—	4X	2.00"		
	—	5X	1.50"		
15X #1147 (Eye Relief 17.0 mm) 	Standard #268	—	10X	1.00"	4.0"
		—	15X	0.75"	
		20X	20X	0.50"	
		—	30X	0.33"	
		—	40X	0.25"	
		—	—	—	
	2X #265	—	20X	0.50"	1.5"
		—	25X	0.38"	
		40X	40X	0.25"	
		—	60X	0.17"	
		—	80X	0.13"	
	2/3X #267	—	7X	1.50"	4.4"
		—	10X	1.12"	
		13.3X	13.3X	0.75"	
		—	20X	0.50"	
		—	25X	0.37"	
	1/2X** #266	—	5X	2.00"	8.0"
		—	7X	1.50"	
		10X	10X	1.00"	
		—	15X	0.66"	
		—	20X	0.50"	
	1/3X** #K1932	—	3.3X	3.00"	12.5"
		—	5.0X	2.25"	
		6.7X	6.7X	1.50"	
—		10X	1.00"		
—		12.5X	0.75"		
1/5X** #1877	—	2X	5.00"	20"	
	—	3X	3.75"		
	4X	4X	2.50"		
	—	6X	1.65"		
	—	8X	1.25"		

*To convert inch values to millimeters: multiply by 25.4

**for CYCLOPTIC Series 52, 53, 55, 59, only

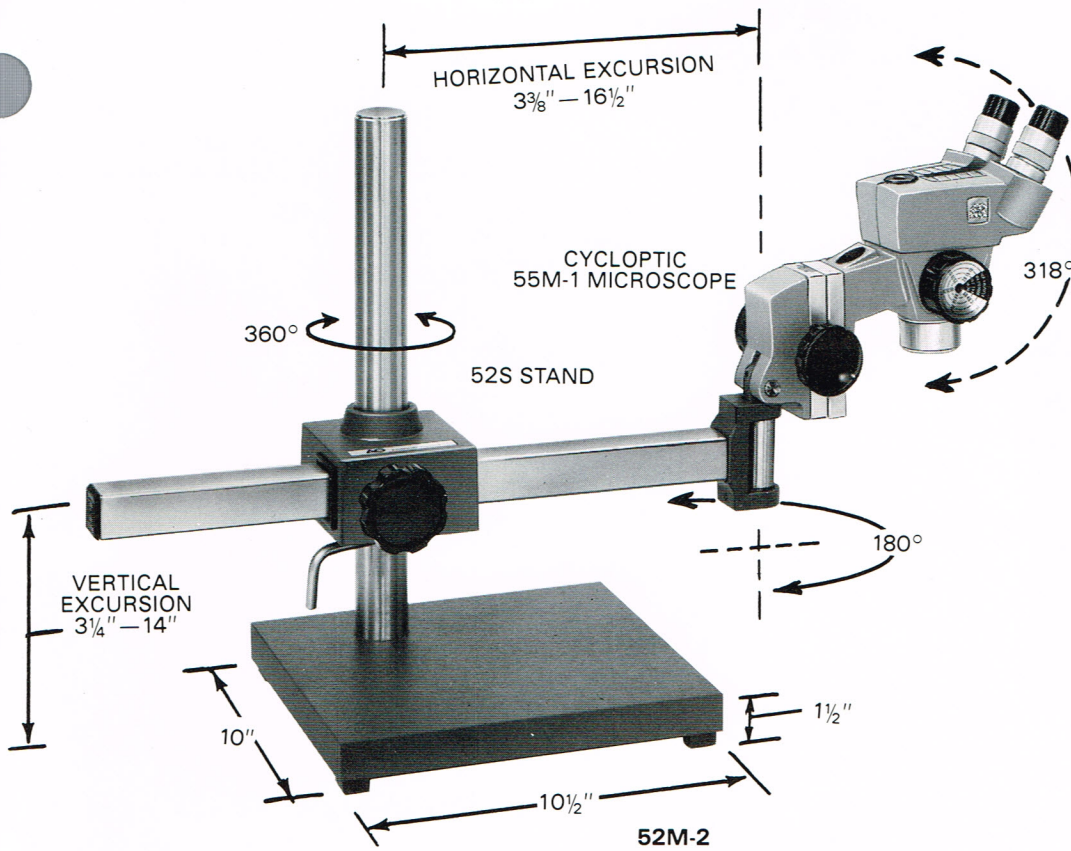

SERIES 52

Standard Economy Table Stand 52S, with manual adjustments for vertical pillar and horizontal arm.

22S Intermediate Table Stand is also available and may be substituted at additional cost. It is heavier, more substantial and offers additional mechanical articulations.

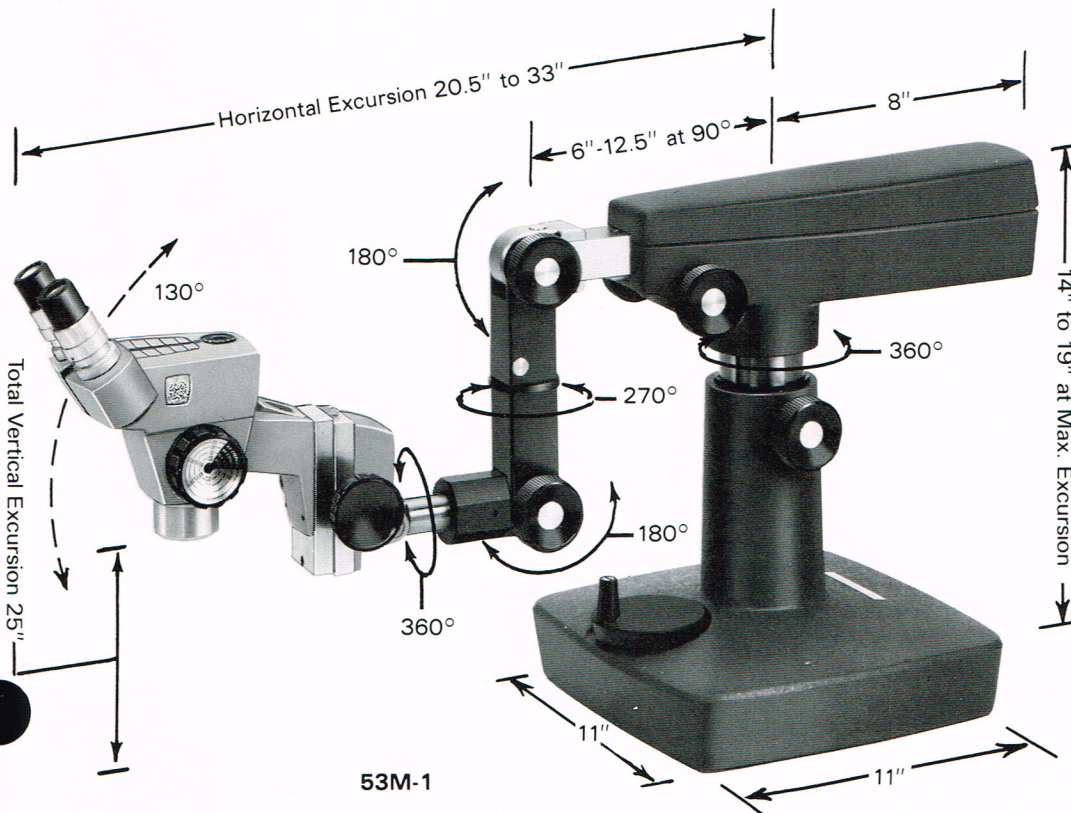

SERIES 53

Universal Table Stand allows positioning in any direction for complete flexibility. Rack and pinion adjustments control horizontal movement and a convenient handwheel adjusts vertical positioning. Arm is counterbalanced for secure instrument placement.

SERIES 56

Standard, basic stand for industrial and educational applications for examination of opaque specimens. With glass insert and stage clips.

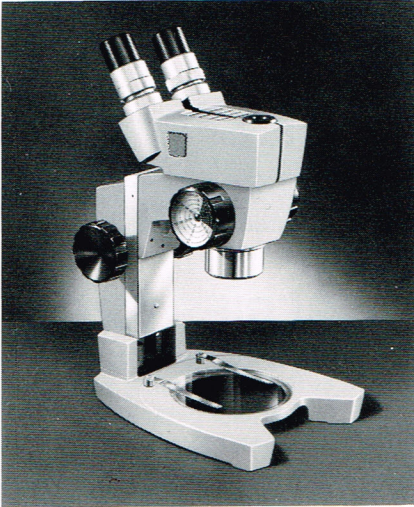

56M-1

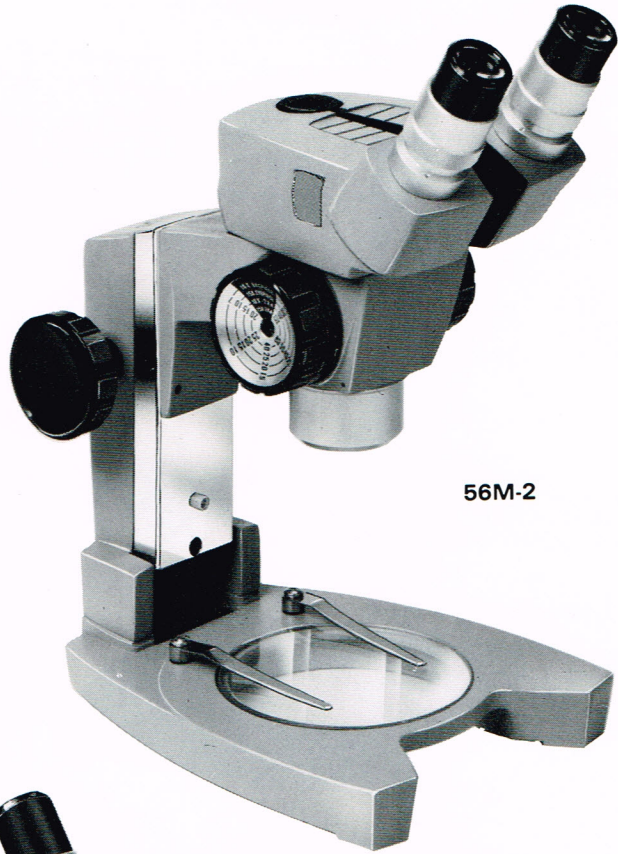

56M-2

SERIES 58

Substage transilluminating base facilitates examination of transparent and semi-transparent specimens.

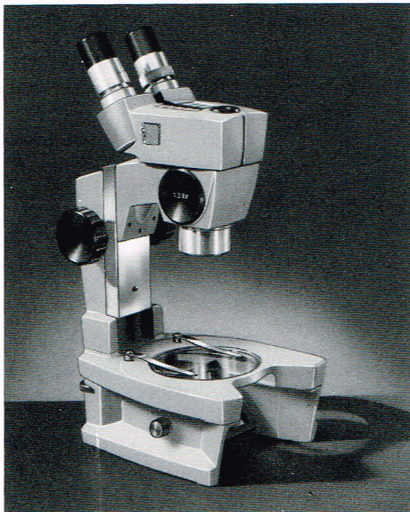

58F-1



58M-1

SERIES 59

Permits important adaptability for industrial uses. Consists of 55 Body and its component parts: Coarse focusing adapter, detachable basestage with glass insert and stage clips.

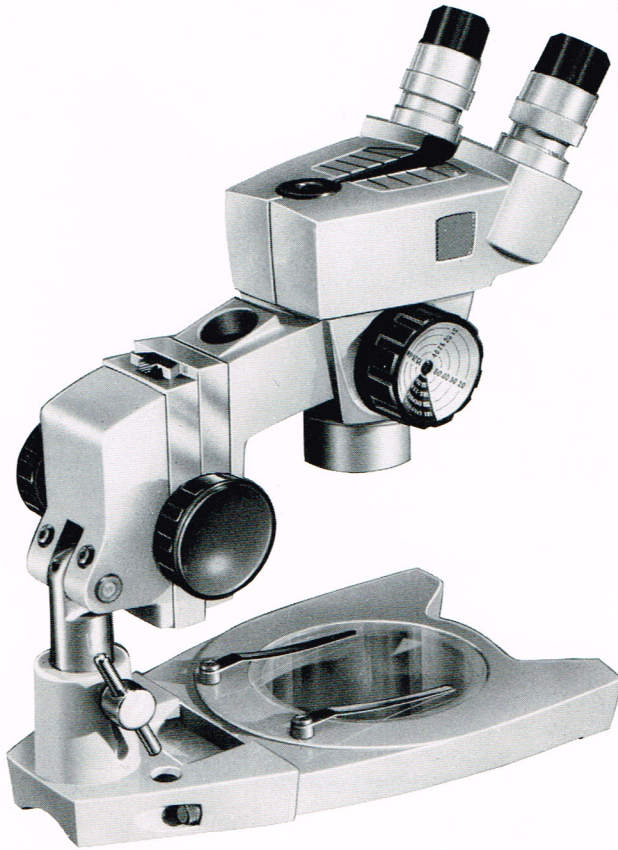

59M-2

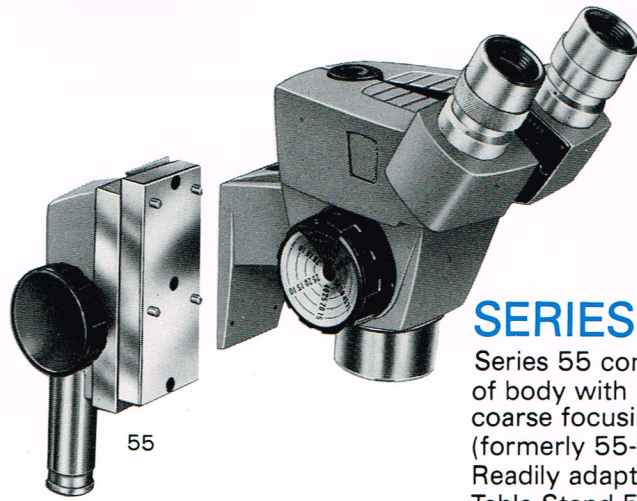

55

SERIES 55

Series 55 consists of body with coarse focusing adapter (formerly 55-800) only. Readily adaptable to Standard Table Stand 52S, Universal Table Stand 53S and special fixtures. See Price List for available models.

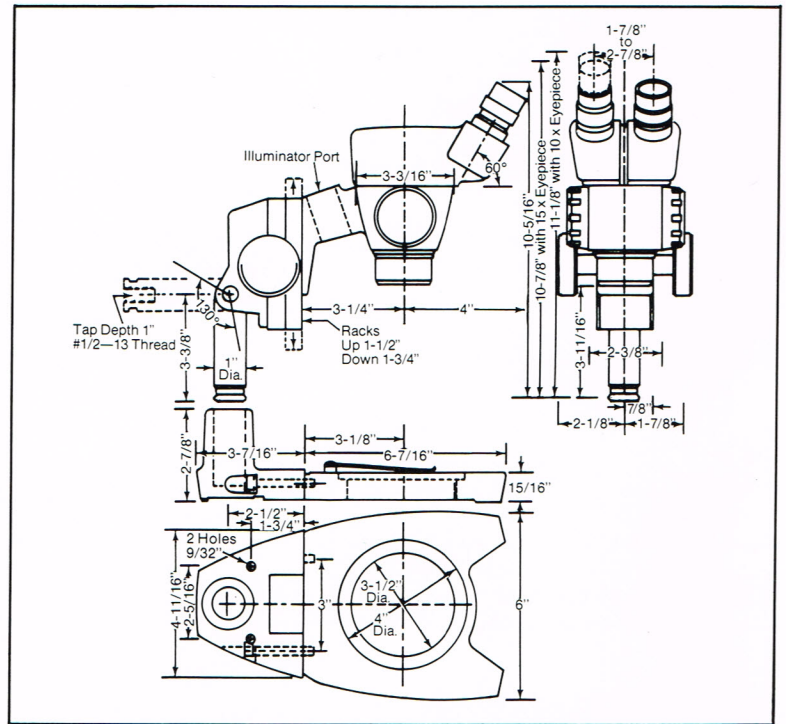

SERIES	52	53	56	58	59	Eyepieces Wide Field	Magnifications	Working Distance
FIXED MAGNIFICATION "F"	52F-1		56F-1	58F-1		10X	15X	4"
	52F-2		56F-2	58F-2		15X	20X	4"
MAGNI-CHANGER "M"	52M-1	53M-1	56M-1	58M-1	59M-1	10X	7X, 10X, 15X, 20X, 25X	4"
	52M-2	53M-2	56M-2	58M-2	59M-2	15X	10X, 15X, 20X, 30X, 40X	4"
DUAL OBSERVATION "DO"			D056M-2	D058M-2		15X Pair	10X, 15X, 20X, 30X, 40X	4"

CABINETS Cabinets are available at additional cost. See Price List.
 No. 1656 Cabinet for Series 56F and 56M.
 No. 1658 Cabinet for Series 58F and 58M.
 No. 1659 Cabinet for Series 59M.
 Cabinets are not available for 52, 53 and 55 Series.

PHOTOMICROGRAPHIC CAMERAS

No. 680A 3¼" x 4¼"
Polaroid Film
Pack Camera



No. 680B 35mm Camera

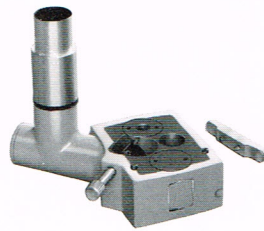

No. 638

3¼" x 4¼" Polaroid® Film Pack Camera, No. 680A and 35mm Camera, No. 680B

Both types of cameras are easily accommodated to all models of CYCLOPTIC Microscopes equipped with a No. 638 Photographic Tube Assembly. (No. 638 is not included in Models 680A and 680B and must be ordered separately.)

Camera outfits include Camera Back, Focusing Eyepiece, Fixed Beam Splitter, Shutter, Cable Assembly and No. 680 Eyepiece Tube Adapter for use with No. 638 Photographic Tube Assembly. Precise focus and exposure achieve excellent color or black and white photomicrographs. Image remains visible through one eyepiece during exposure. Shutter speeds are 1/125 through 1 Second, Time and Bulb.

Single Photographic Tube Assembly, No. 638

Required for use with Nos. 680A and 680B Photomicrographic Cameras.

Entire unit can be quickly attached to any model CYCLOPTIC Microscope. Focusing is accomplished through the conventional binocular portion of the microscope. A flip-out mirror then diverts the light from one tube of the binocular body to the Photographic Tube Adapter. Does not include eyepiece. Order No. 146, 147, or 157.

TV Adapter, No. K2688

For use with No. 638 Photographic Tube Assembly. Permits use of all standard "C" mount television cameras and provides a convenient method for extended use of a stereoscopic microscope as an inspection tool.

® T.M. Reg. by Polaroid Corporation

MOBILE STAND

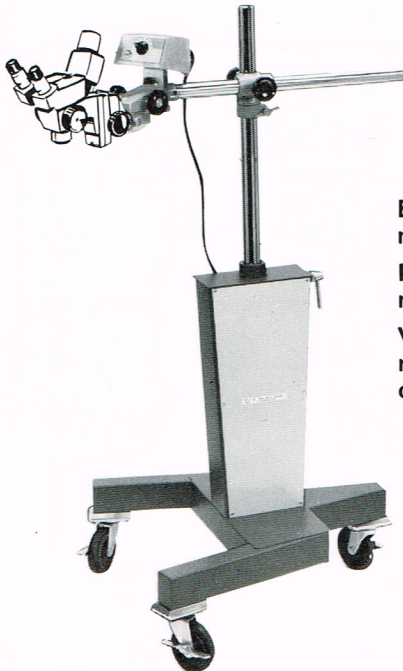

Easy, convenient mobility

Rigid, balanced microscope support

Variable height and rotation positioning of instrument

Mobile Stand No. K2309

Invaluable for those special applications where a stereomicroscope must be moved to the specimen.

Internal constant force springs safely counterbalance weight of microscope, illuminator and transformer.

Stand Movements:

Height adjustment—37" to 52" above floor.
Horizontal adjustment—instrument can be positioned from 6" to 33½" from vertical post.

Simply release locking handle, and move post up or down. Lock securely at desired height.

The sturdy, 3-leg base support is finished in a dark gray scuff-resistant coating, with attractive light gray contrasting side panels.

Heavy duty casters lock individually to secure movement of stand when in position.

The 15' grounded cord is factory installed.



No. DO56M-2 with No. 653 Universal Illuminator

Dual Observation CYCLOPTIC Microscope

The important option of a dual observation system is offered which greatly extends the use of these microscopes for training, teaching and consultation. Operator of microscope focuses image with one eyepiece tube adjustment; observer can adjust for eye refraction differences by rotating collar adjustments on both eyepiece tubes. Models available have Magni-Changer for dial-in selection of 10X, 15X, 20X, 30X and 40X magnifications. 15X Wide Field eyepieces are supplied. See Illuminator section for best choice of light sources based on individual requirements.

No. 270 Dual Observation Conversion Kit may be purchased for existing CYCLOPTIC Microscopes. This includes Dual Converter, extra prism body and 15X Wide Field eyepieces. (Recommended for use only with 15X or higher, Wide Field eyepieces.)



No. 270 Dual Observation Conversion Kit

Twin-View Stereo Microscope

Developed as a training instrument for detailed instruction in the intricacies of sub-miniature component production, its chief advantage is that it allows two persons to view *exactly* the same image simultaneously. The same well-corrected image from microscope is relayed to second binocular body *without any loss of clarity, field size or magnification*.

Housing is 37½" x 3" wide x 3½" high. Each observer is at a comfortable 35" distance apart and there is generous room to accommodate large jigs, fixtures, etc.

Magni-Changer of microscope provides dial-in selection of magnifications. Working distance is a constant 4" for most magnifications. No. 265 2X Auxiliary Lens is a recommended accessory as it allows higher magnifications.

Stand, consisting of base with rack and pinion focusing pillar, and locking device, is included in outfit. Range of focus is 3½". (Customer has the option of providing fixture for focusing of object.)

No. 653 Universal Illuminator provides a compact, intense light source. See Illuminator section.

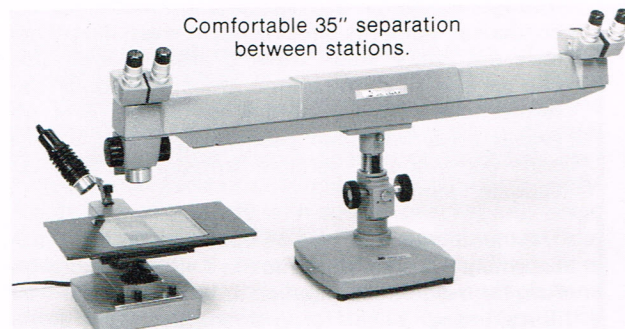

No. K2666 w/653H

No. K1632-1

Staging Platform, No. K2665

Provides a convenient method of supporting and maneuvering specimens. The large, solid stage has 4"x4" or optional 6"x6" XY travel for larger specimens, particularly suitable for use with 53S Universal Stand, No. K2309 Mobile Stand and No. K1632 Twin View.

Staging Platform, No. K2666

Similar to the No. K2665 but offers the additional advantage of a built-in 20W Halogen Illuminator.

Illumination controls include a variable intensity regulator, adjustable field diaphragm and flip-in neutral density filter. A quick-change lamp socket allows easy lamp replacement.

The stand is exceptionally stable; its mechanical stage with glass plate also has 4"x4" or optional 6"x6" XY motions. Supplied with ground glass plate for low power work and clear glass plate for high power work.

SPECIFICATIONS

Eyepiece	Magnification	Working Distance
10X	7X, 10X, 15X, 20X, 25X	4"
15X	10X, 15X, 20X, 30X, 40X	4"
With 2X Auxiliary Lens Attachment		
10X	15X, 20X, 30X, 40X, 50X	1½"
15X	20X, 30X, 40X, 60X, 80X	1½"



STARLITE™ Illuminator, No. 369

More light with less heat

This microscope illuminator assures cool operation throughout extended periods of use. Fixed prefocused condenser elements direct brilliant, even illumination over the entire stage viewing area. Unique quick-change securing stud allows attachment onto transformer base. The three-link adjustable arm with swivel gives unlimited positioning range. Supplied with continuously variable transformer, 6V, 20W Tungsten lamp.

The illuminator may also be used without the linkage assembly. It is simply set into the Twin-Port Microscope Arm for incident illumination or inserted in the transilluminating base for transmitted illumination. UL listed.

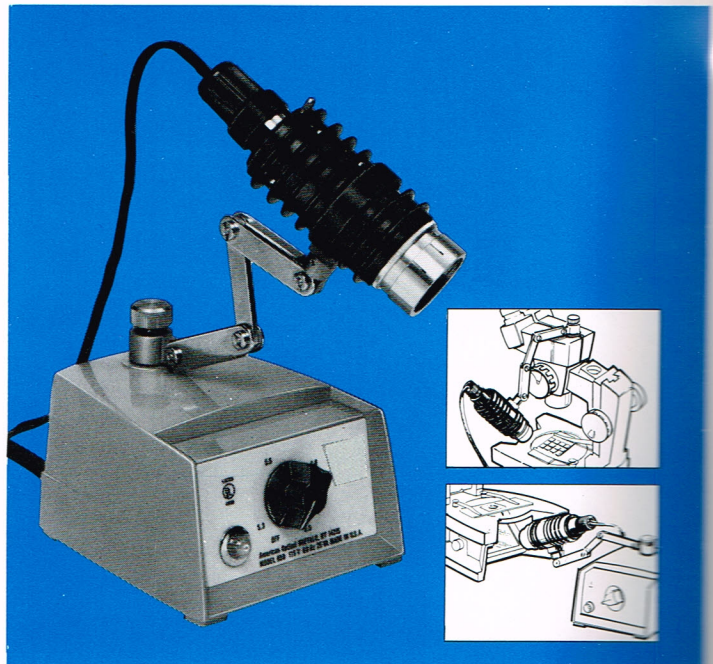
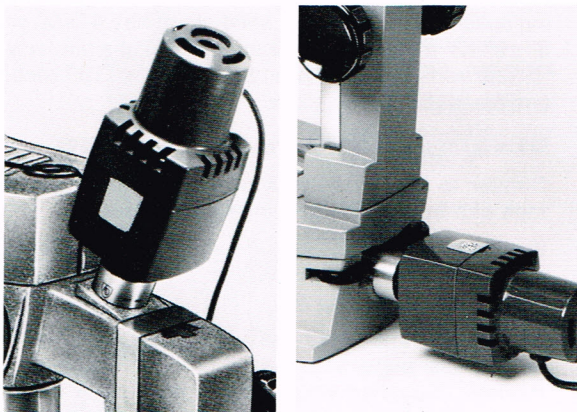

Universal Microscope Illuminator, No. 653

- Compact, intense light source
 - Variable voltage control
- Focusable triple lens condensing system
- Adjustable to any angle above or below stage
 - Accommodates neutral density, color filters and iris diaphragm

The intense 6V, 20W Tungsten lamp, coupled with an efficient condensing system, provides excellent illumination for incident and transmitted light applications. A continuously variable transformer is supplied as standard. A three-lens optical system, in a spiral focusing mount, offers the added advantage of a focusable condensing system to concentrate the intense light beam as required. The mount also provides support for the filter holder or accessory iris diaphragm.

The all-metal illuminator housing is mounted on a three-link jackknife arm which is readily fitted onto the stereoscopic microscope or transformer. *The illuminator is easily adjustable to any angle, either above or below the stage.* UL listed.

FILTERS

Blue glass, daylight, heat-absorbing glass, ground glass disc and neutral density filters of 5%, 25% and 50% transmission are available. Filters have a diameter of 31.45mm and are inserted in the cap filter holder which slips over the front of the focusing mount.



IRIS DIAPHRAGM

An iris diaphragm, which controls the field aperture, also accommodates the above filters. It replaces the cap filter holder and slips over the front of the condenser focusing mount.





Internal Vertical Illuminator, No. K1730

The Internal Vertical Illuminator is a valuable stereo microscope accessory for industrial applications where critical inspection and assembly of micro components is required.

It allows specular reflecting specimens to be seen in true color fidelity, making visual inspection of integrated microcircuit components more definitive. In addition, an enhanced stereo image quality is also achieved, as illuminator is an integral part of the optical system of the microscope.

The Internal Vertical Illuminator may be used with any CYCLOPTIC Microscope, and with the addition of a 1.33X fixed objective, affords the full 4" working distance at 20-40X magnifications. This permits ample clearance between objective lens and work area to fully accommodate the various types of fixtures normally used in inspection and assembly. The 2X Auxiliary Lens can be used for higher magnifications, 40X-80X, with a reduction of working distance to 1.5". This illuminator is recommended for magnifications of 20X and higher. Includes transformer.

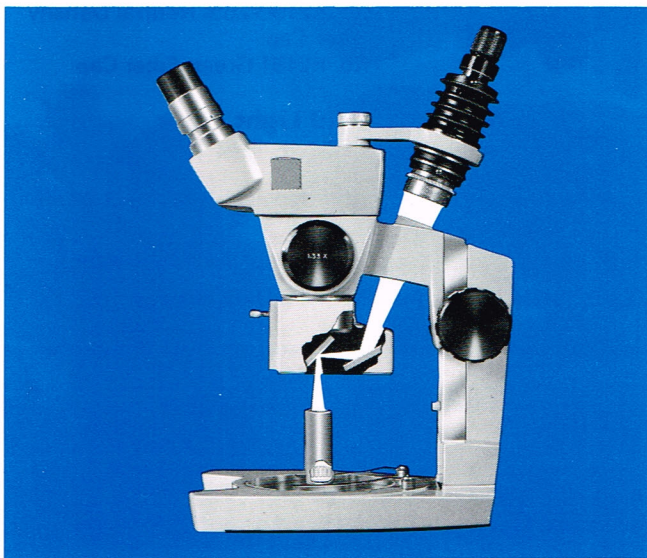

Vertical Quartz Illuminator No. 340A

The Vertical Illuminator permits examination of deep orifices where the angle is too acute for oblique illumination methods. This illuminator extends the advantages of stereoscopic microscopy to a great variety of new problems ranging from the inspection of small I.D. borings in machined parts or castings to delicate ear surgery. It consists of a lamphouse with special bracket and hinge pin for attachment to CYCLOPTIC stand; a vertical reflector that mounts over objective or auxiliary lens attachment; and a variable transformer. A multiple lens focusing system permits you to critically focus the intense light to match the working distances of the standard objective, the 2/3X auxiliary lens attachment, and the 1/2X and 1/3X special long working distance objectives.

No. 341A consists of lamphouse and transformer, only, for No. 340A.



Fluorescence Ring Illuminator, No. 384

Provides ideal illumination for viewing three-dimensional objects under the stereomicroscope. A circular fluorescent lamp covers the entire stage with bright, even, shadowless light. High color temperature is well suited for photomicrography.

"Instant-on" lamp is cool to the touch and designed for long life.

Threaded reflector lamp housing is easily and quickly attached to any STEREOSTAR Zoom or CYCLOPTIC Microscope (without auxiliary lens). UL listed.

High Intensity Fiber Optic Illuminator Outfit, No. 1175H

Includes 20" Double Branch Light Guide No. 1175 so that object can be illuminated from any two directions. Stay-put sheathing is easily maneuvered and retains its position over extended periods. No. K2192 Aspheric Condensers for concentrated light output are available. Outfit also includes No. 1177 fan-cooled, 150W Fiber Optic Illuminator.

Filter Caps are available:

- No. K2180 50% Neutral Density Filter Cap
- No. K2190 25% Neutral Density Filter Cap
- No. K2191 Green Filter Cap

Brilliant, Cold Light Fiber Optic Illuminator, No. 1177

Outstanding for photomicrography and for most general purpose illumination.

High intensity continuously variable 150W light source.

Quiet, low-vibration fan cools 150W illuminator.

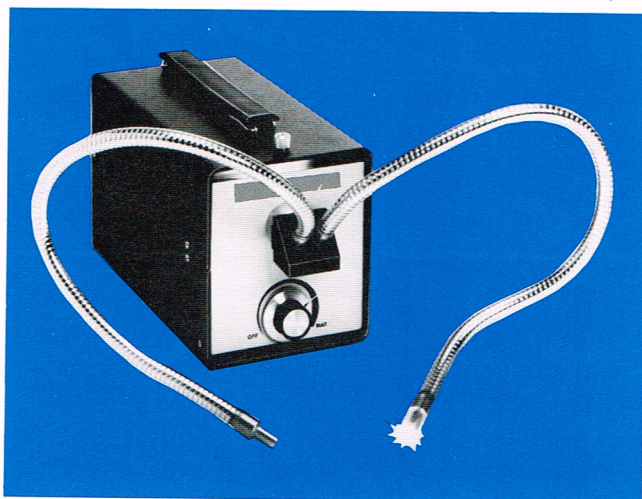

8 Pt. Fiber Optic Ring Illuminator Outfit, No. 1178H

Light Guide delivers brilliant, even illumination from 8 distinct points. Outfit includes No. 1177, No. 1178 8 pt. Fiber Optic Ring and No. 1179 Microscope Adapter.

CYCLOPTIC APPLICATIONS

The Microscope Adapter (supplied) threads directly onto bottom of basic objective on all CYCLOPTIC Bodies. Ring is then locked into place over it by tightening thumb screw.

It can be used with No. 266 1/2X special objectives, No. 267 2/3X Auxiliary Lens attachment as well as with No. 268 standard objective. Adapter is then reversed and fastened over lens by set screws.

Filar Micrometer Eyepieces

These precision instruments, used in conjunction with a microscope, assure extreme accuracy and eliminate many tedious, time-consuming calibration factors.

Accuracy greatly exceeds that of a simple micrometer scale. The graduated micrometer drum has 100 increments or divisions. This drum moves the fiducial line precisely one reticle scale division for each revolution. Thus, the drum reads to 1/100 of the scale division.

Both Reichert Micrometer Eyepiece Models (English or Metric Scales) have a knurled thumbscrew to control the lateral position of the reticle scale. Such scale movement greatly expedites measuring speed as the scale zero setting, or the most adjacent scale division, can quickly be made to exactly coincide with one edge of the specimen.

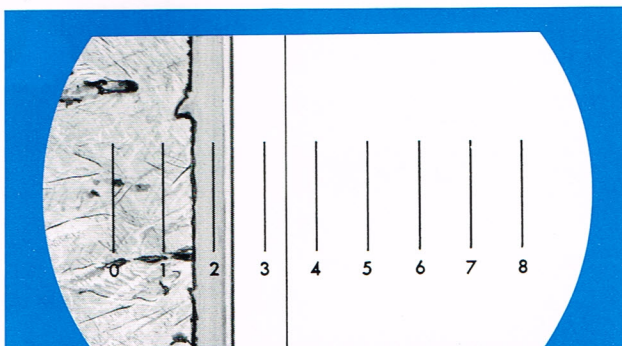
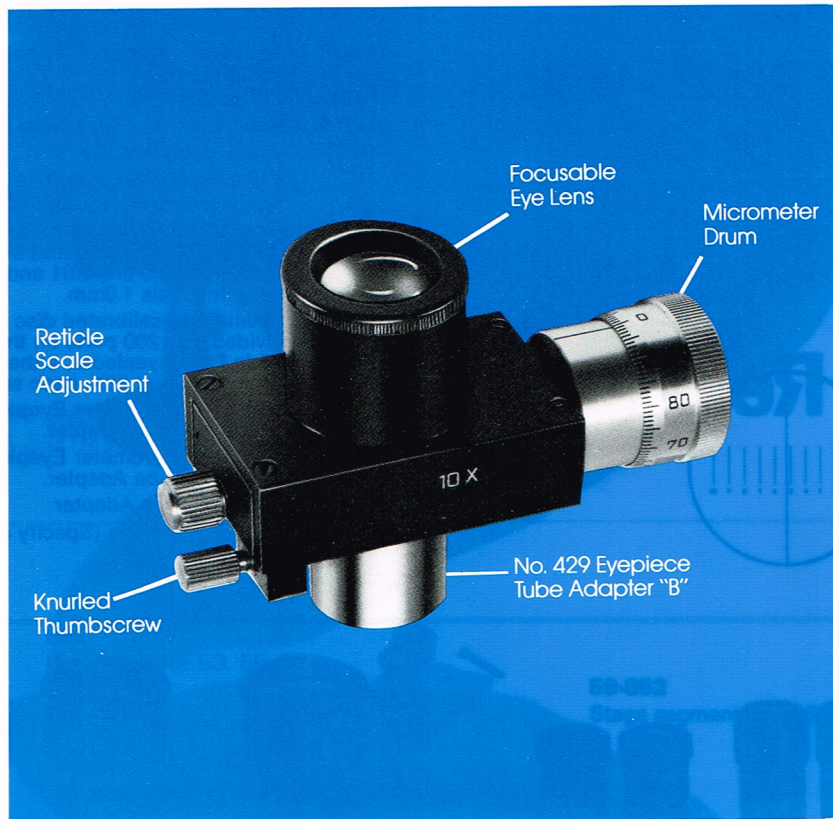

ENGLISH SCALE — Model No. 424B

The reticle scale is 0.4 inch long. It is subdivided into eight equal increments of .05 inch each. The graduated micrometer drum has 100 divisions, each equal to .0005 inch.

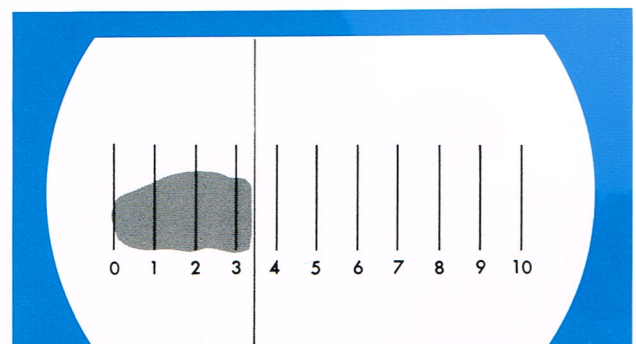

METRIC SCALE — Model No. 426B

The reticle scale is 10mm long. It is subdivided into ten equal increments of 1mm each. The graduated micrometer drum has 100 divisions, each equal to .01mm or 10 (microns).

CYCLOPTIC ACCESSORIES

MEASURING AND COUNTING ACCESSORIES FOR 437, 146, 146B, 147, 147B, 157, 157B EYEPIECES

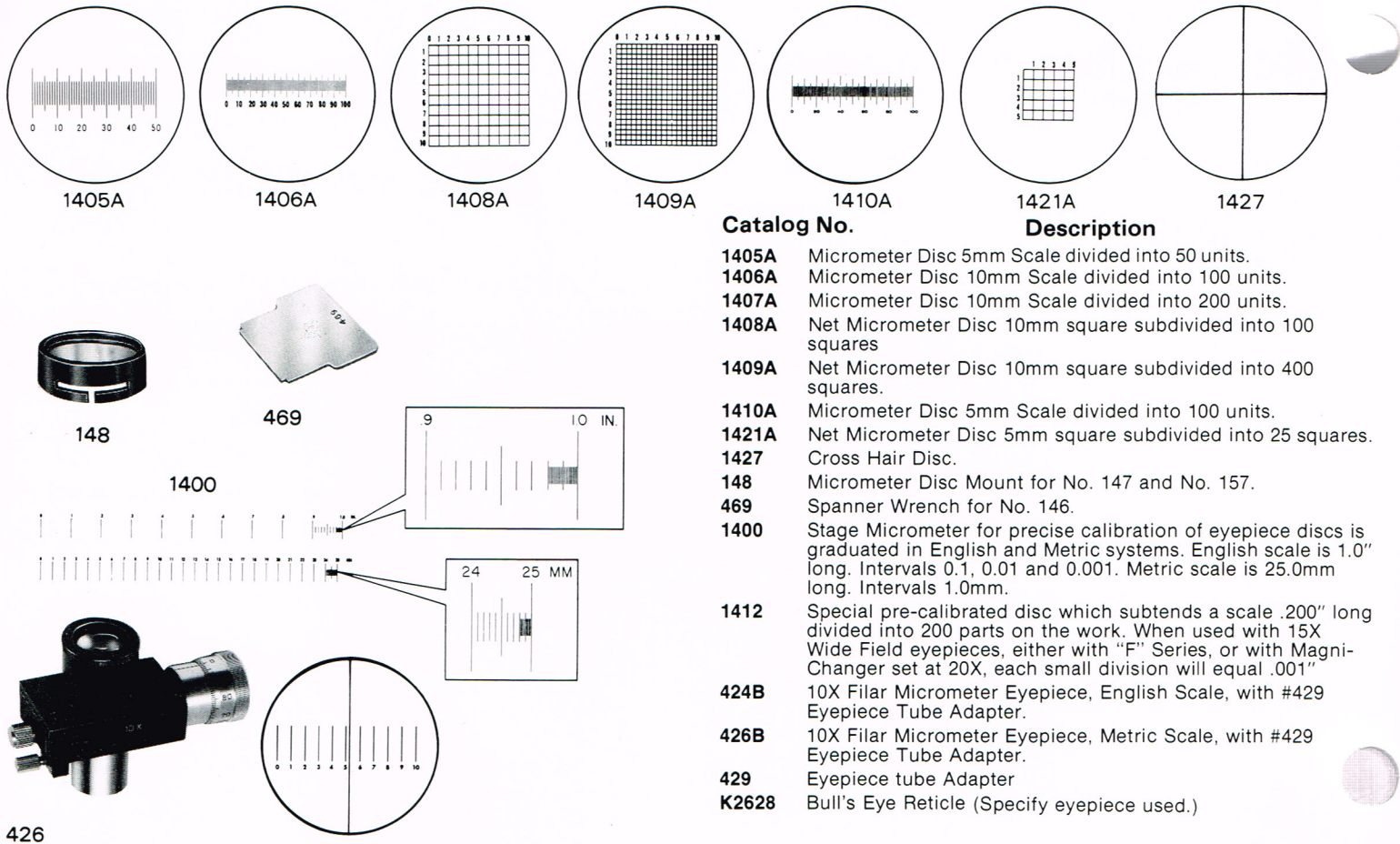

Catalog No. **Description**

1405A Micrometer Disc 5mm Scale divided into 50 units.

1406A Micrometer Disc 10mm Scale divided into 100 units.

1407A Micrometer Disc 10mm Scale divided into 200 units.

1408A Net Micrometer Disc 10mm square subdivided into 100 squares

1409A Net Micrometer Disc 10mm square subdivided into 400 squares.

1410A Micrometer Disc 5mm Scale divided into 100 units.

1421A Net Micrometer Disc 5mm square subdivided into 25 squares.

1427 Cross Hair Disc.

148 Micrometer Disc Mount for No. 147 and No. 157.

469 Spanner Wrench for No. 146.

1400 Stage Micrometer for precise calibration of eyepiece discs is graduated in English and Metric systems. English scale is 1.0" long. Intervals 0.1, 0.01 and 0.001. Metric scale is 25.0mm long. Intervals 1.0mm.

1412 Special pre-calibrated disc which subtends a scale .200" long divided into 200 parts on the work. When used with 15X Wide Field eyepieces, either with "F" Series, or with Magni-Changer set at 20X, each small division will equal .001"

424B 10X Filar Micrometer Eyepiece, English Scale, with #429 Eyepiece Tube Adapter.

426B 10X Filar Micrometer Eyepiece, Metric Scale, with #429 Eyepiece Tube Adapter.

429 Eyepiece tube Adapter

K2628 Bull's Eye Reticle (Specify eyepiece used.)

426



1146 10X W.F. AMERICOTE, Pair

1147 15X W.F. AMERICOTE, Pair

1157 20X W.F. AMERICOTE, Pair

146 10X W.F. AMERICOTE, Single

147 15X W.F. AMERICOTE, Single

157 20X W.F. AMERICOTE, Single

186 25X W.F. Single

K1848 15X W.F. Focusable, Single

*Accepts standard reticles for 1146, 1147, and 1157 Eyepieces.

EYESHIELDS

149 For Eyepieces 1146 and 1147. Two required.

178 Rubber fold down. Fits all standard Reichert eyepieces. Two required.



268 Standard objective

266 1/2X Special long working distance objective for 52, 53, 55, 59 only

262 3/4X Special objective

K1877 1/5X objective, 20" working distance

K1932 1/3X objective, 12 1/2" working distance

ACHROMATIC AUXILIARY LENS—ATTACHMENTS

267 2/3X Auxiliary Lens—Attachment

265 2X Auxiliary Lens—Attachment

269 Stage plates Number 269 are intended for use with CYCLOPTIC Microscope Series 56, 58, and 59... the set of two formica opaque plates—one white and the other black—are interchangeable with or may be specified instead of standard glass insert plates supplied with CYCLOPTIC Series 56, 58, and 59 at no additional cost.

269 Black and white stage plates... Set

261 Glass Stage Plate for 56, 58, 59.

BASE, STANDS, CABINETS

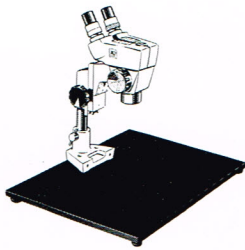

30B
Phenolic-resin base-board 12" x 17"

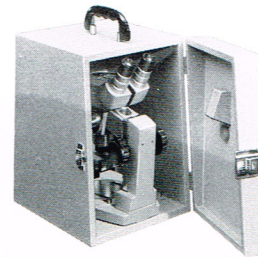

1656 Cabinet for 56
1658 Cabinet for 58
1659 Cabinet for 59

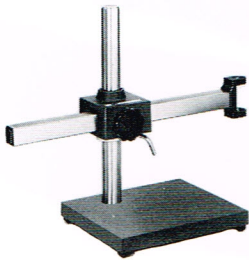

52S
Economy Table Stand Model 52S may be substituted for Universal Table Stand Model 53S or Base Stage Model 59S supplied as standard with CYCLOPTIC Series 53 and 59 respectively. See separate listing for Series 52.



22S
Intermediate Table Stand Model 22S may be substituted for Universal Table Stand Model 53S or Base-Stage Model 59S supplied as standard with Cycloptic Series 53 and 59 respectively. See separate listing for Series 22.



53S
Universal Table Microscope Stand for 53, 55, 59

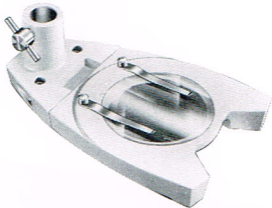

59S
Base-stage for 53, 55, 59

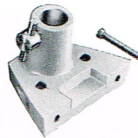

59-851
Post receptacle with locking lever for 53, 55, 59

59-852
Stage segment of 59S

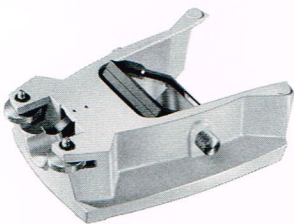
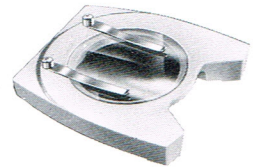

58S
Transilluminating sub-stage base with mirror for 56, 58, 59



584
3" Extension rod for 55, 59



585
Lens protecting window and cell



We've Changed Our Name
from AO to Reichert

ReichertTM

Reichert Scientific Instruments

Division of Warner-Lambert Technologies, Inc.
P.O. Box 123, Buffalo, New York 14240 U.S.A.
(716) 891-3000